

Ronse
Lighting

A PROFESSIONAL
MANUFACTURER

New Catalogue

2019/2020



FOSHAN RONSE LIGHTING TECHNOLOGY CO.,LTD

ADD: Liansha Industrial Zone,,Nanhai,Foshan,Guangdong,China

TEL:+86-757-86609916 FAX:+86 757 86614760

E-mail:export@ronse.cc Http://www.ronse.cc www.ronselighting.com

Our sunshine ,light up the world

ABOUT US

Foshan Ronse Lighting Technology Co.,Ltd. is a National high-tech enterprises of R&D,Manufacturing ,Marketing and Services in LED application lighting products, located in Danzao Town,Nanhai,Foshan ,Guangdong, as a professional manufacturer with a long history, our company has accumulated rich experience in research and development and marketing in this burgeoning led application lighting industry .

After many years' development, Ronse Lighting has developed to be one of professional manufacturers for led lighting products, and own Workshop Area more than 30,000 M2 , we adopt advanced processing equipments, automatic CNC processing equipments , automatic paint spraying apparatus and testing equipment; own professional and veteran team in R&D,, management and sales, we Strictly implement ISO9001:2000 international quality management system standard, all of our products have passed CE, SAA,RoHS,TUV,CCC certificate, and own several patents.

Main products of Ronse Lighting include: led spot light , led ceiling light , led down light , led grille light , led pendant light and led bulbs etc. are including Several series of products like high power LED, SMD ,COB etc.

“safe and energy-saving, Green and environment friendly” is our design concept, “Enthusiasm and Honest, Technological innovation” is our management philosophy , we always pursue more beautiful and practical products , With excellent quality and best after-sales service , our products have been sell very well in many countries , and Won trust and high praise from our customers.

Looking to the future, we will continue to explore, constantly beyond, with somebody like you from all over world.



Product designs are basing on market and art



Because light is indispensable for our life, the quality of the product that can be used for a long time and the quality of the light that makes a human-friendly light environment are very important. RONSE has always pursued a high level of quality realized by skilled engineers and our corporate structure. We continue our commitment to the "quality" - safety and durability, the quality of light, and the spaces that synchronize with the light.

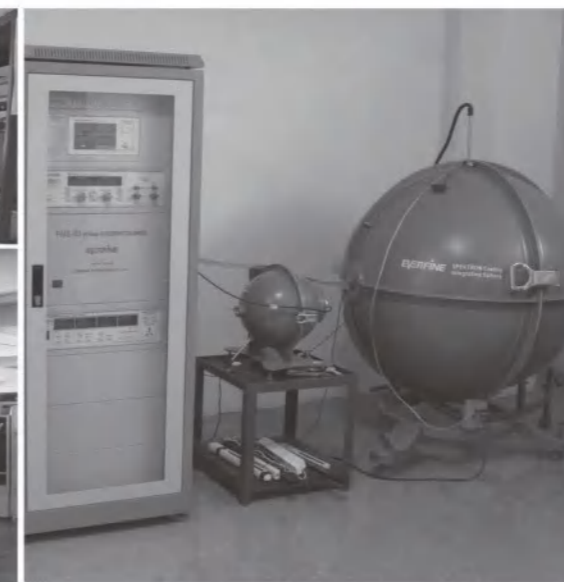

Enterprise honor/Product certification

An honor, represents a kind of pursuit, reflects a kind of effect, symbolizes a kind of ability, hastens a kind of motivation. An authentication, carries a passion, expresses a recognition, supports a concept and enjoys a result.

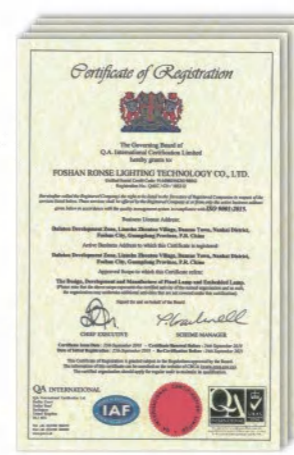
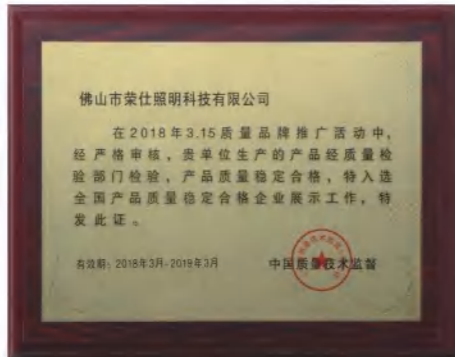

ISO

RoHS

SAA



CE

CCC

Letters Patent

TUV

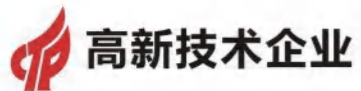

优质制造商



Full spect

The full spectrum refers to the spectrum of ultraviolet, visible, and infrared light in the spectrum, and the ratio of red, green, and blue in the visible portion is similar to that of sunlight, and the color rendering index is close to that of 1.

Ra

There are fifteen colors in the index index. The average of the first eight common color rendering indexes is recorded as Ra, which characterizes the color rendering of the light source.

- R1: Light gray red R2: Dark gray yellow R3: Saturated yellow green
- R4: Medium yellow green R5: Light blue green R6: Light blue
- R7: Light purple blue R8: Light red purple R9: Saturated red
- R10: Saturated yellow R11: Saturated green R12: Saturated blue
- R13: White human skin color R14: Leaf green R15: Yellow color

**IT TURNS OUT THAT LIFE CAN BE MORE BEAUTIFUL.
RESTORE THE LIGHT OF NATURE**

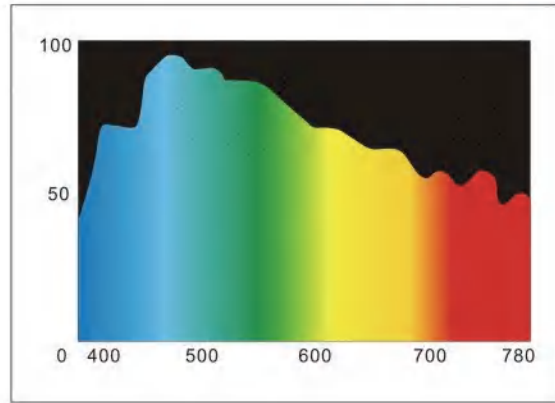

Color rendering index >90
Brighter colors and more direct

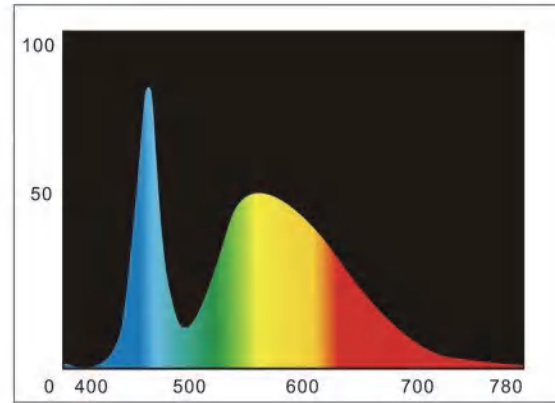

Color rendering index >80
Ordinary color



Make colors more realistic

The color rendering index as high as $Ra \geq 90$ is closer to the natural color of the object

TIPS: color rendering index: the ability parameter of the light source to restore the true color against the object



Improve physical desire



Increase product purchase desire

Full spectrum subdivision lighting application

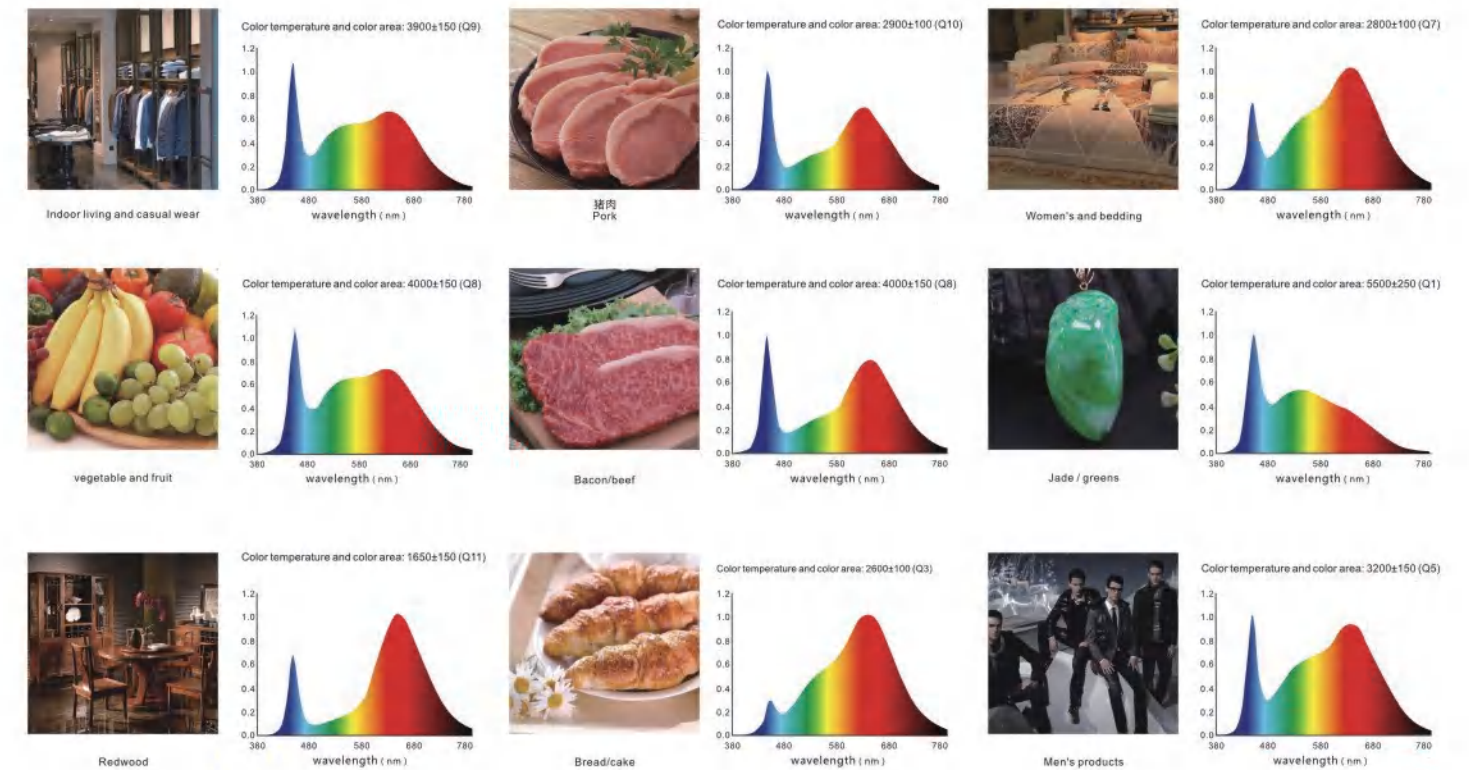

ADVANCED OPTICAL TECHNOLOGY

Developed by adopting world top class optics technology and processed in scientific and strict techniques to guarantee the optical quality of this series TIR lens used in products can make the beam angle precisely with clean and even light spot without dark area, stray light and other defects. And the products are with precise lighting distribution and high efficient output, soft, even and clean light without dark area or halo.

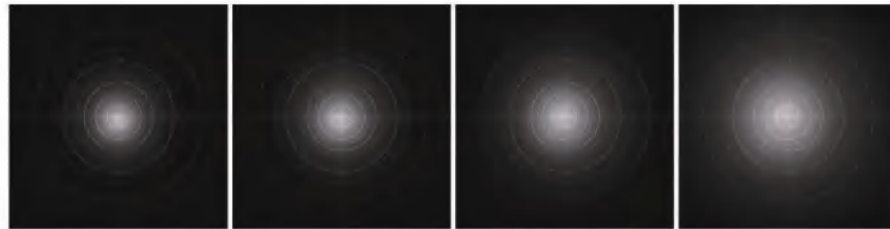
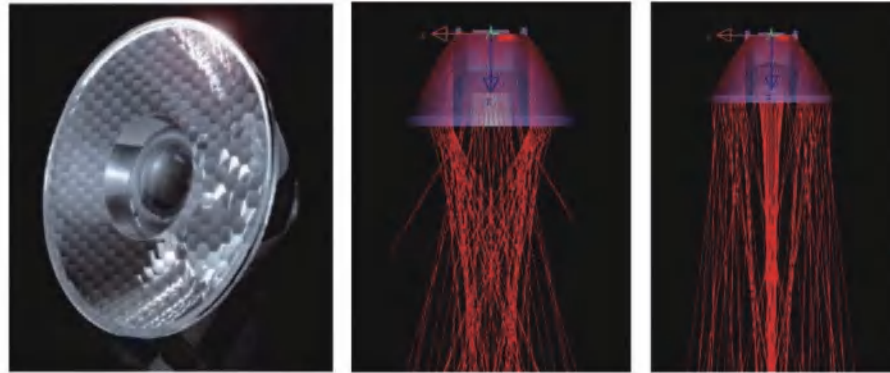

10° 12° 24° 36°

THE LATEST HIGH QUALITY FREE SURFACE REFLECTIVE CUP, UNIFORM LIGHT, NO YELLOW RING, NO GLARE.

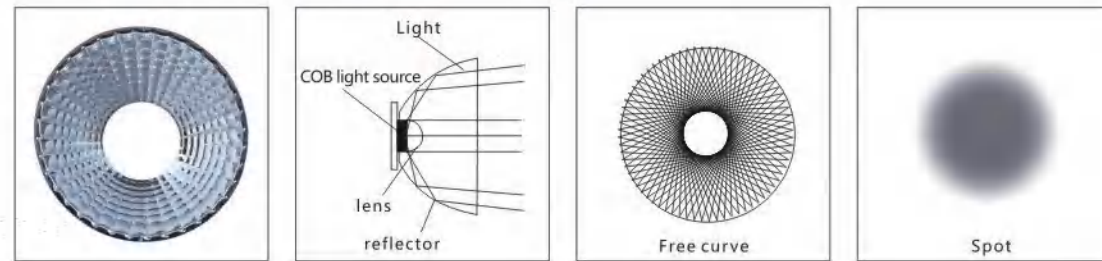

The convex mirror reflector surface is carefully designed, can produce micro reflection, on the premise of no reducing optical performance to improve the light distribution, so as to improve the efficiency of lamps. It can choose interchangeable reflector to change beam, including in the case of the spotlight being installed.

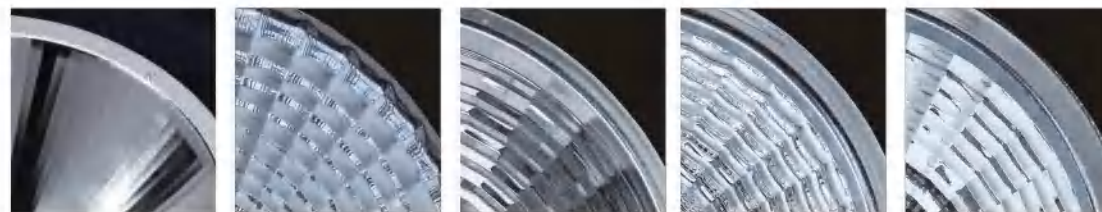

Ultra narrow light Narrow light Medium wide light Wide light Broader light

THE DESIGN OF RADIATOR

How to deal with the problem about the radiator, it is the core content which can help the led product working more stable. If the led chips had been working under high temperature, it would cause the problem about the large light fades, unstable color temperature, and short lifetime of chips. The professional design of radiator can provide more space for air convection to decrease the product temperature.

- The selection of high quality material
Depending on the different characteristic and the requirements of the application, it will help us to choose the high quality material of heat sink.
- High quality of the producing technology
With the special producing technology, the LED chips will combine with the radiator closely, so that it can make sure the function of radiator play the biggest role in the product.

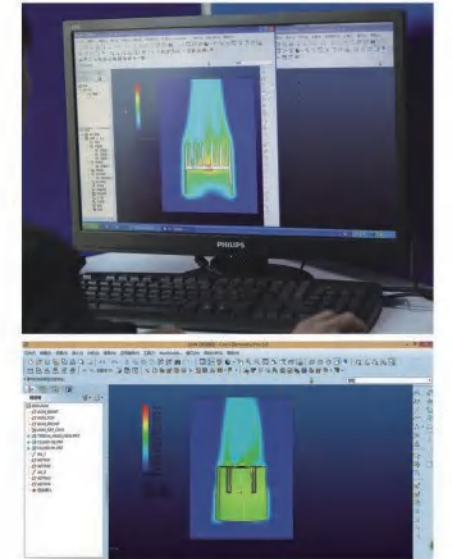

DRIVER

- control of IC
 - Electrolytic & capacitors
 - suitable design of driver circuit
- The quality and matching of drive power play a decisive role. We are relying on using the reliable quality and stable performance key accessories to make sure the data and service life suitable for the LED light source. The average lifespan is set as 3000h, and the warranty is 3 years.

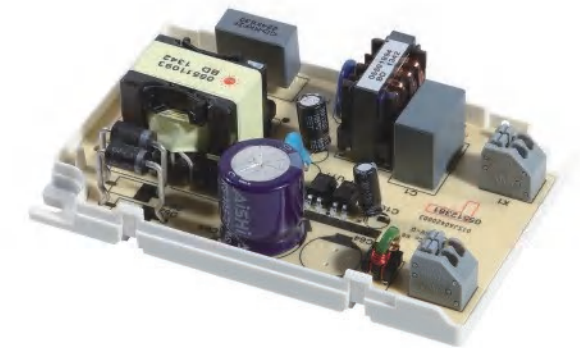

Strategic Globalization



A global network supports quality and speed

A global network is one of the big advantages for the international business. Our representatives around the world identify customer's needs and provide a considerate service; overseas develop and manufacture products based on the customer's voice collected by sales staff. This strong teamwork between sales and production enables us to speedily provide a high quality lighting.

RONSE lighting

Product Catalogue
2019/2020

Track light angle adjustable series	P.001-010
Linear track light series	P.011-018
Track light series	P.019-080
Magnetic lamp series	P.081-094
Ceiling light series	P.095-100
Downlight series	P.101-116
Spot light series	P.117-126
Grille light series	P.127-156
Surface mounted downlight series	P.157-162
Hanging light series	P.163-180
Flood light series	P.181-188



RONSE LIGHTING
TRACK LIGHT ANGLE
ADJUSTBALE SERIES



GD19P20A PAGE 003



GD16P10R PAGE 005



GD16P10A PAGE 007



GD18F80B PAGE 009



GD19Y30A PAGE 010



OPTIONS

Driver
KGP 科谷奇源 **TRIDONIC** **PHILIPS**
 A.non-dimmable B.TRIAC
 C.1-10V D.DALI

COB
CITIZEN **ORIGALE** **ORIGALE** **CREE** **VS LIGHTING SOLUTIONS**
 3000K 4000K 5000K

Finish
 Standard **WH**
 Optional **BK**

COB Beam angle
 15-60

Adapter
 1-phase (2 wires) 1-phase (3 wires) 3-phase (4 wires)
 Adapter driver

PHOTOMETRIC

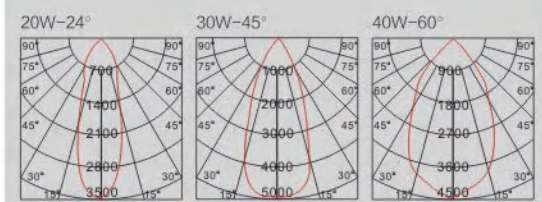

GD19P20A



GD19P30A



GD19P40A

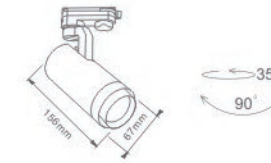

COB 20W

CRI	Ra≥80 / Ra≥90
Luminous Flux	1750Lm
Input voltage	180-265VAC/50-60Hz

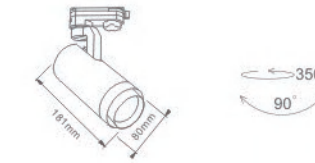

COB 30W

CRI	Ra≥80 / Ra≥90
Luminous Flux	2720Lm
Input voltage	180-265VAC/50-60Hz

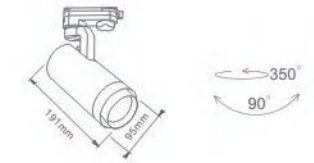

COB 40W

CRI	Ra≥80 / Ra≥90
Luminous Flux	3640Lm
Input voltage	180-265VAC/50-60Hz



OPTIONS

Driver

KGP 科谷电源 TRIDONIC PHILIPS

A.non-dimmable B.TRIAC

C.1-10V D.DALI

COB

CITIZEN 科锐照明 CREE VS LIGHTING SOLUTIONS

3000K 4000K 5000K

Finish

Standard WH

Optional BK

COB Beam angle



Adapter

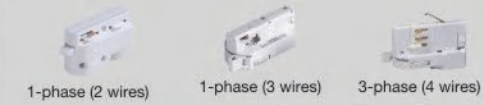

PHOTOMETRIC

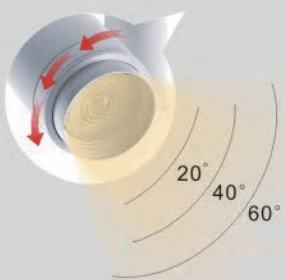
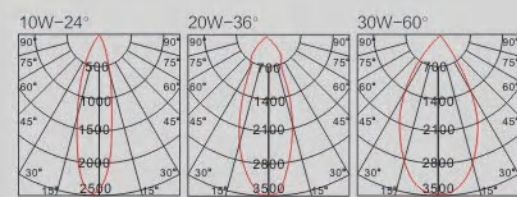

GD16P10R



GD16P20R



GD16P30R



GD16P40R

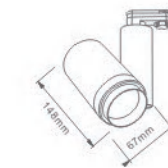

350°
90°

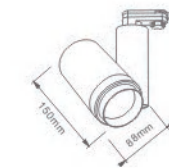

350°
90°

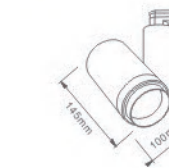

350°
90°

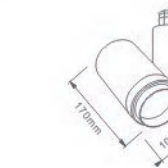

350°
90°

COB 10W

CRI Ra≥80 / Ra≥90
Luminous Flux 750Lm
Input voltage 180-265VAC/50-60Hz

COB 20W

CRI Ra≥80 / Ra≥90
Luminous Flux 1790Lm
Input voltage 180-265VAC/50-60Hz

COB 30W

CRI Ra≥80 / Ra≥90
Luminous Flux 2780Lm
Input voltage 180-265VAC/50-60Hz

COB 40W

CRI Ra≥80 / Ra≥90
Luminous Flux 3830Lm
Input voltage 180-265VAC/50-60Hz



PATENTED PRODUCTS 201510179699.7

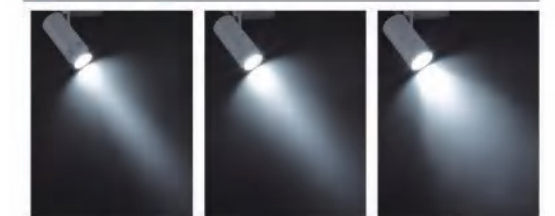

20° 40° 60°

OPTIONS

Driver

KGP 科谷光源 PHILIPS

A.non-dimmable B.TRIAC
C.1-10V D.DALI

COB

CITIZEN 三洋 CREE VS LIGHTING SOLUTIONS

3000K 4000K 5000K

Finish

Standard WH

Optional BK

COB Beam angle



Adapter



PHOTOMETRIC

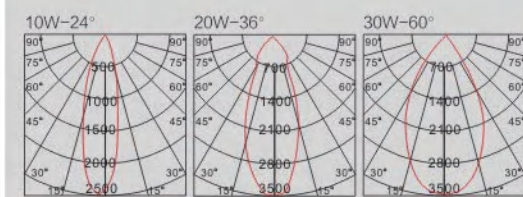

GD16P10A



GD16P20B



GD16P30C



GD16P40C

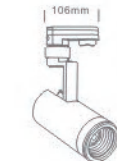

COB 10W

CRI Ra≥80 / Ra≥90
Luminous Flux 730Lm
Input voltage 180-265VAC/50-60Hz



COB 20W

CRI Ra≥80 / Ra≥90
Luminous Flux 1740Lm
Input voltage 180-265VAC/50-60Hz



COB 30W

CRI Ra≥80 / Ra≥90
Luminous Flux 2710Lm
Input voltage 180-265VAC/50-60Hz



COB 40W

CRI Ra≥80 / Ra≥90
Luminous Flux 3580Lm
Input voltage 180-265VAC/50-60Hz



PATENTED PRODUCTS 201510179699.7



20° 40° 60°

GD18F80B

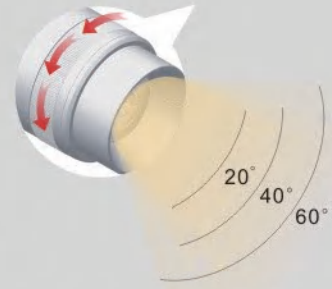

COB 80W

CRI Ra≥80 / Ra≥90
 Luminous Flux 6120Lm
 Input voltage 180-265VAC/50-60Hz

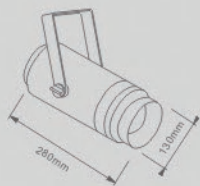

OPTIONS

Driver

KGP 科谷光源 TRIDONIC PHILIPS

A.non-dimmable B.TRIAC
 C.1-10V D.DALI

COB

CITIZEN Citizen LED 晶利 LED CREE VS LIGHTING SOLUTIONS

3000K 4000K 5000K

Finish

Standard WH

Optional BK

COB Beam angle



Adapter

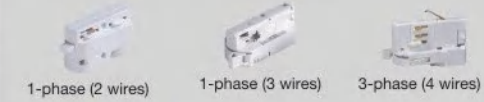

Adapter driver

GD19Y30A



COB 30W

CRI Ra≥80 / Ra≥90
 Luminous Flux 2750Lm
 Input voltage 180-265VAC/50-60Hz

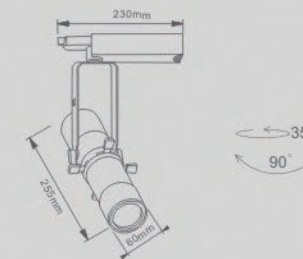

OPTIONS

Driver

KGP 科谷光源 TRIDONIC PHILIPS

A.non-dimmable B.TRIAC
 C.1-10V D.DALI

COB

CITIZEN Citizen LED 晶利 LED CREE VS LIGHTING SOLUTIONS

3000K 4000K 5000K

Finish

Standard WH

Optional BK

Adapter

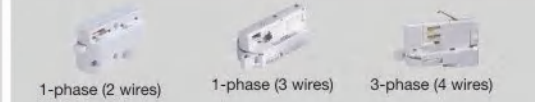

Adapter driver

Spot





RONSE LIGHTING
LINEAR TRACK LIGHT
SERIES



GD18B15C-Z PAGE 013



GD18B20D-Z PAGE 015



GD18B50C PAGE 017



GD18B40S PAGE 018

OPTIONS

Driver

Driver on board
A.non-dimmable

SMD



3000K 4000K 5000K

Finish

Standard WH

Optional BK

SMD Beam angle



Adapter



Accessory



GD18B15C-Z



GD18B30C-Z



GD18B45C-Z

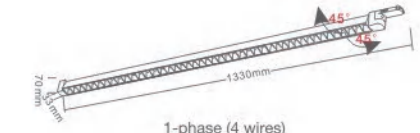
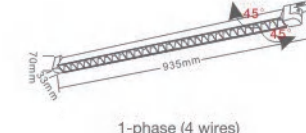
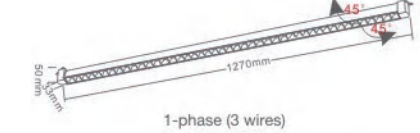
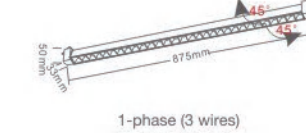
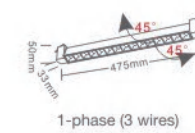
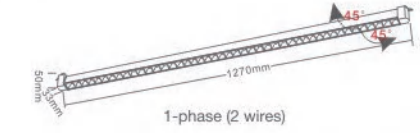
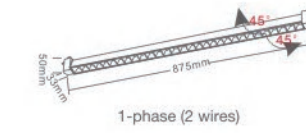
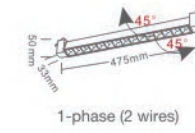

SMD 15W

CRI Ra \geq 80 / Ra \geq 90
Luminous Flux 1125Lm
Input voltage 180-265VAC/50-60Hz

SMD 30W

CRI Ra \geq 80 / Ra \geq 90
Luminous Flux 2250Lm
Input voltage 180-265VAC/50-60Hz

SMD 45W

CRI Ra \geq 80 / Ra \geq 90
Luminous Flux 3375Lm
Input voltage 180-265VAC/50-60Hz



OPTIONS

Driver

Driver on board
A.non-dimmable

SMD



3000K 4000K 5000K

Finish

Standard WH

Optional BK

SMD Beam angle



Adapter



1-phase (2 wires)

1-phase (3 wires)

3-phase (4 wires)

GD18B20D-Z



GD18B40D-Z



GD18B60D-Z

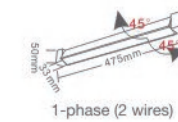
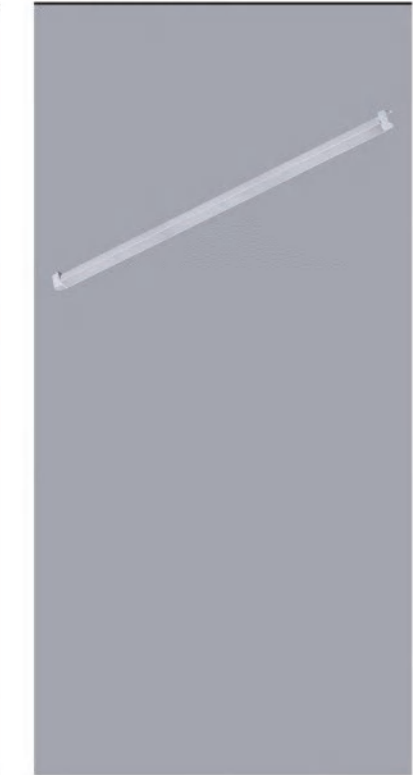

1-phase (2 wires)

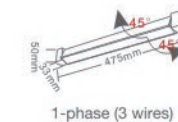

1-phase (3 wires)



1-phase (4 wires)

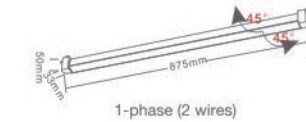

1-phase (2 wires)

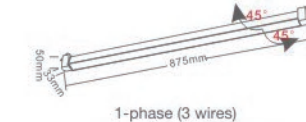

1-phase (3 wires)

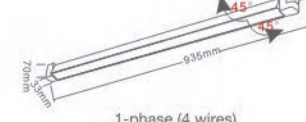

1-phase (4 wires)

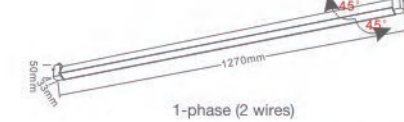

1-phase (2 wires)

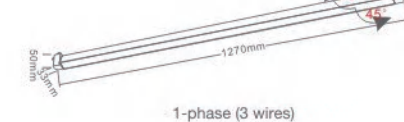

1-phase (3 wires)

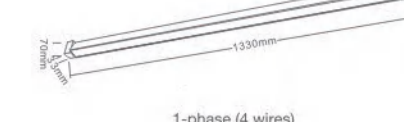

1-phase (4 wires)

SMD 20W

CRI Ra ≥ 80 / Ra ≥ 90
Luminous Flux 1420Lm
Input voltage 180-265VAC/50-60Hz



SMD 40W

CRI Ra ≥ 80 / Ra ≥ 90
Luminous Flux 2840Lm
Input voltage 180-265VAC/50-60Hz



SMD 60W

CRI Ra ≥ 80 / Ra ≥ 90
Luminous Flux 4260Lm
Input voltage 180-265VAC/50-60Hz



GD18B50C



OPTIONS

Driver

KGP 科名光电 LiFud
 A.non-dimmable B.TRIAC
 C.1-10V D.DALI

SMD

BRIDGE LUX 科名光电 CREE
 3000K 4000K 5000K

Finish

Standard WH
 Optional BK

SMD Beam angle



Adapter



Accessory



SMD 50W
 CRI Ra≥80 / Ra≥90
 Luminous Flux 3750Lm
 Input voltage 180-265VAC/50-60Hz

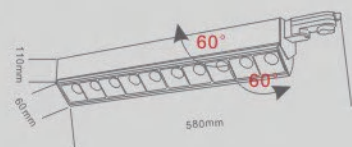
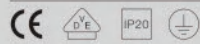

GD18B40S



OPTIONS

Driver

KGP 科名光电 LiFud
 A.non-dimmable B.TRIAC
 C.1-10V D.DALI

SMD

AMTC 科名光电 BRIDGE LUX
 3000K 4000K 5000K

Finish

Standard WH
 Optional BK

SMD Beam angle



Adapter

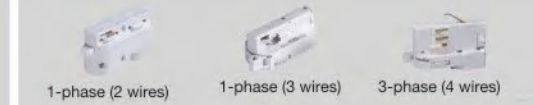

SMD 40W
 CRI Ra≥80 / Ra≥90
 Luminous Flux 3400Lm
 Input voltage 180-265VAC/50-60Hz

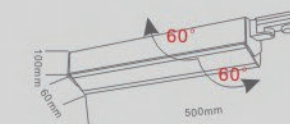



RONSE LIGHTING TRACK LIGHT SERIES

				
GD18A20E PAGE 021	GD18A20F PAGE 023	GD16N20D PAGE 025	GD19K10A PAGE 027	GD19F20A PAGE 029
				
GD19E20A PAGE 031	GD16E40A PAGE 033	GD19C30A PAGE 035	GD19C30C PAGE 037	GD19K10A-4 PAGE 039
				
GD18A10C PAGE 041	GD18C10A PAGE 043	GD18H20B PAGE 045	GD18H30A PAGE 047	GD17J30C PAGE 049
				
GD17K30B PAGE 051	GD16H30C PAGE 053	GD16R30A PAGE 057	GD17L10B PAGE 059	GD18R15A PAGE 061
				
GD16J30A PAGE 064	GD16G40C PAGE 065	GD16H30A PAGE 067	GD16H40A PAGE 069	GD16M30A PAGE 071
				
GD16C10A PAGE 073	GD16B30A PAGE 075	GD02F30A PAGE 077	GD15A40A PAGE 079	GD15A40C PAGE 080



OPTIONS

Driver
KGP PHILIPS POWERGEAR
 A.non-dimmable B.TRIAC
 C.1-10V D.DALI

COB
CITIZEN **ORICALE** **CREE** **VS LIGHTING SOLUTIONS**
 ● 3000K ● 4000K ● 5000K

Finish
 Standard WH
 Optional BK

COB Beam angle

 15 24 36

Adapter

 1-phase (2 wires) 1-phase (3 wires) 3-phase (4 wires)

Adapter driver 1-phase (2 wires) 3-phase (4 wires)

PHOTOMETRIC

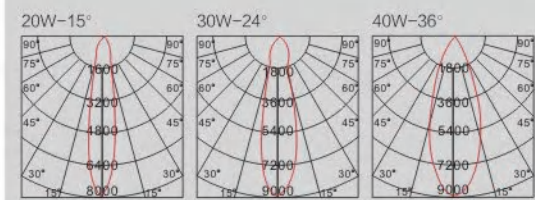

GD18A20E



GD18A30E



GD18A40E

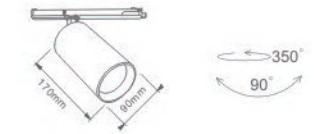
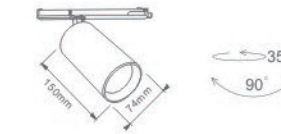
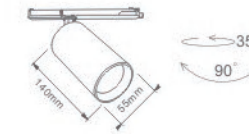

COB 20W

CRI	Ra≥80 / Ra≥90
Luminous Flux	1860Lm
Input voltage	180-265VAC/50-60Hz



COB 30W

CRI	Ra≥80 / Ra≥90
Luminous Flux	2740Lm
Input voltage	180-265VAC/50-60Hz



COB 40W

CRI	Ra≥80 / Ra≥90
Luminous Flux	3750Lm
Input voltage	180-265VAC/50-60Hz



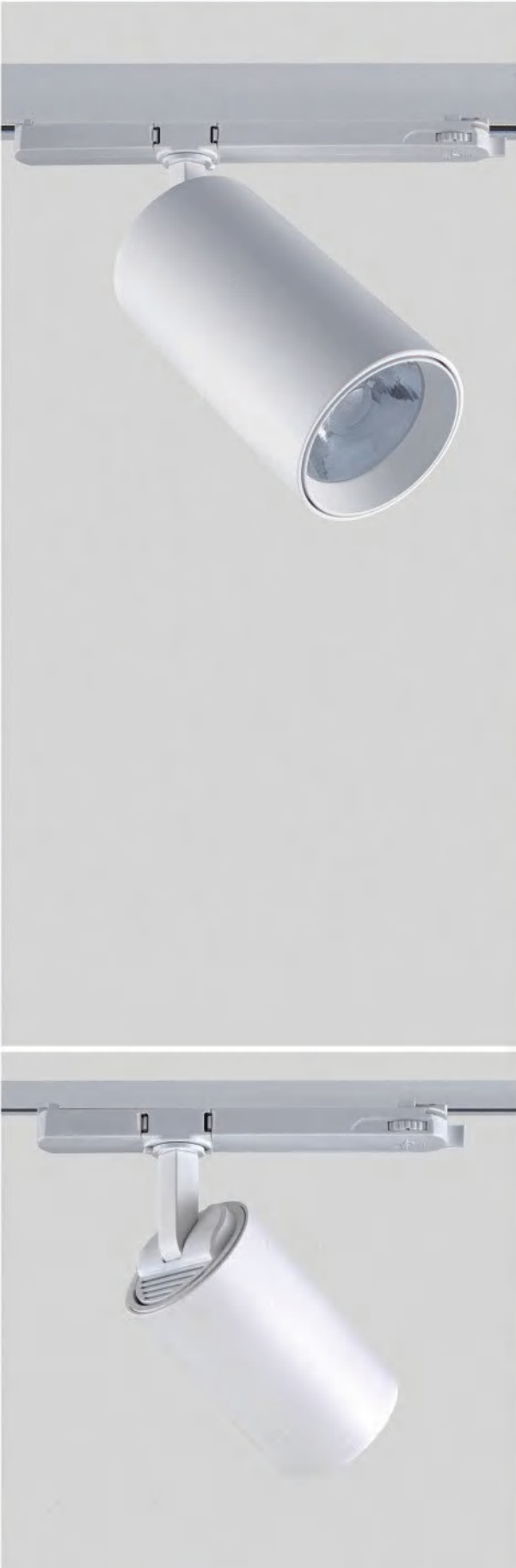

OPTIONS

Driver
KGP PHILIPS POWERGEAR
 A.non-dimmable B.TRIAC
 C.1-10V D.DALI

COB
CITIZEN **ORICALE** **CREE** **VS LIGHTING SOLUTIONS**
 ● 3000K ● 4000K ● 5000K

Finish
 Standard WH
 Optional BK

COB Beam angle

 15 24 36

Adapter

 1-phase (2 wires) 1-phase (3 wires) 3-phase (4 wires)

Adapter driver 1-phase (2 wires) 3-phase (4 wires)

PHOTOMETRIC

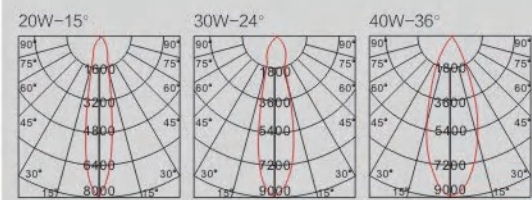

GD18A20F



GD18A30F



GD18A40F

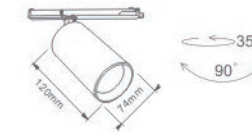

COB 20W

CRI	Ra≥80 / Ra≥90
Luminous Flux	1860Lm
Input voltage	180-265VAC/50-60Hz

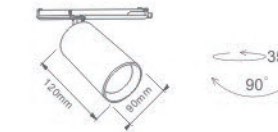

COB 30W

CRI	Ra≥80 / Ra≥90
Luminous Flux	2710Lm
Input voltage	180-265VAC/50-60Hz

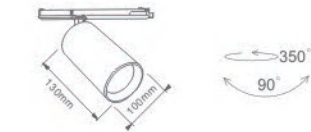

COB 40W

CRI	Ra≥80 / Ra≥90
Luminous Flux	3590Lm
Input voltage	180-265VAC/50-60Hz





OPTIONS

Driver
KGP PHILIPS POWERGEAR
 A.non-dimmable B.TRIAC
 C.1-10V D.DALI

COB
CITIZEN HORIGLE 同利精工 CREE VS LIGHTING SOLUTIONS
 3000K 4000K 5000K

Finish
 Standard **WH**
 Optional **BK**

COB Beam angle
 12° 24° 36°

Adapter

1-phase (2 wires) 1-phase (3 wires) 3-phase (4 wires)

Adapter driver 1-phase (2 wires) 3-phase (4 wires)

PHOTOMETRIC

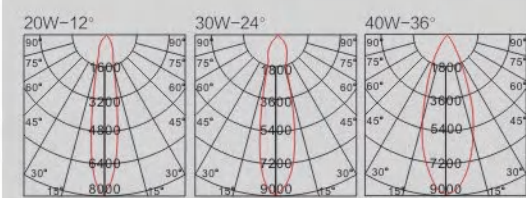

GD16N20D

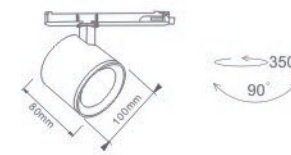

COB 20W

CRI	Ra≥80 / Ra≥90
Luminous Flux	1790Lm
Input voltage	180-265VAC/50-60Hz



GD16N30D

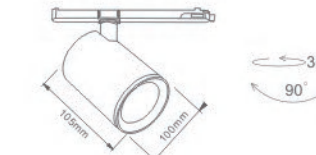

COB 30W

CRI	Ra≥80 / Ra≥90
Luminous Flux	2760Lm
Input voltage	180-265VAC/50-60Hz



GD16N40D

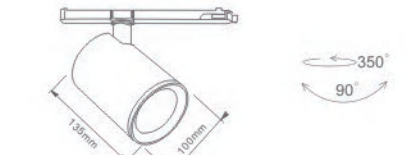

COB 40W

CRI	Ra≥80 / Ra≥90
Luminous Flux	3610Lm
Input voltage	180-265VAC/50-60Hz





OPTIONS

Driver
KGP PHILIPS POWERGEAR
 A.non-dimmable B.TRIAC
 C.1-10V D.DALI

COB
CITIZEN **ORICALE** **CREE** **VS LIGHTING SOLUTIONS**
 ● 3000K ● 4000K ● 5000K

Finish
 Standard **WH**
 Optional **BK**

COB Beam angle

 15° 23° 38° 45° 60°

Adapter

 1-phase (2 wires) 1-phase (3 wires) 3-phase (4 wires)
 Adapter driver 1-phase (2 wires) 3-phase (4 wires)

PHOTOMETRIC

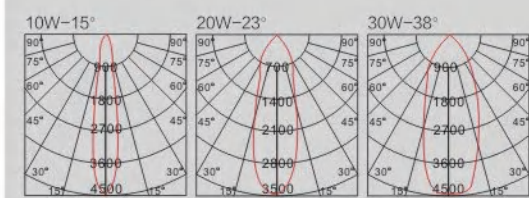

GD19K10A

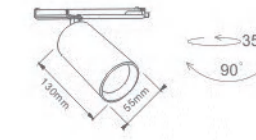

COB 10W

CRI Ra \geq 80 / Ra \geq 90
 Luminous Flux 810Lm
 Input voltage 180-265VAC/50-60Hz



GD19K20A

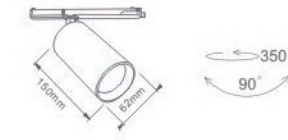

COB 20W

CRI Ra \geq 80 / Ra \geq 90
 Luminous Flux 1620Lm
 Input voltage 180-265VAC/50-60Hz



GD19K30A

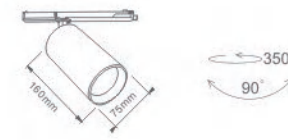

COB 30W

CRI Ra \geq 80 / Ra \geq 90
 Luminous Flux 2430Lm
 Input voltage 180-265VAC/50-60Hz



GD19K40A

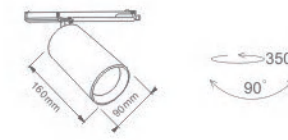

COB 40W

CRI Ra \geq 80 / Ra \geq 90
 Luminous Flux 3210Lm
 Input voltage 180-265VAC/50-60Hz



OPTIONS

Driver

KGP 科谷特 TRIDONIC PHILIPS

- A.non-dimmable B.TRIAC
- C.1-10V D.DALI

COB

CITIZEN 三晶光电 HONGGAI 鸿冠照明 CREE VS LIGHTING SOLUTIONS

- 3000K 4000K 5000K

Finish

Standard WH

Optional BK

COB Beam angle



Adapter



PHOTOMETRIC

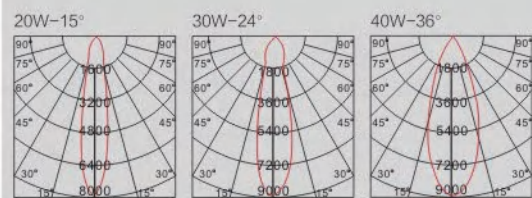

GD19F20A

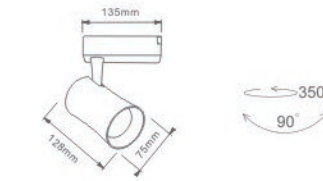

COB 20W

CRI	Ra≥80 / Ra≥90
Luminous Flux	1890Lm
Input voltage	180-265VAC/50-60Hz



GD19F30A

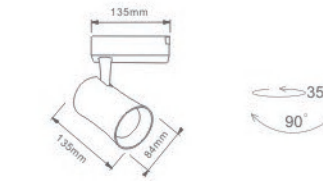

COB 30W

CRI	Ra≥80 / Ra≥90
Luminous Flux	2770Lm
Input voltage	180-265VAC/50-60Hz



GD19F40A

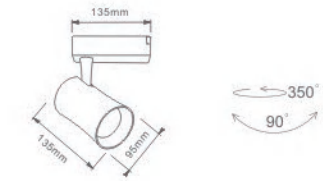

COB 40W

CRI	Ra≥80 / Ra≥90
Luminous Flux	3720Lm
Input voltage	180-265VAC/50-60Hz



OPTIONS

Driver

KGP 科谷特 TRIDONIC PHILIPS

A.non-dimmable B.TRIAC
C.1-10V D.DALI

COB

CITIZEN 西村照光 CREE VS LIGHTING SOLUTIONS

3000K 4000K 5000K

Finish

Standard WH

Optional BK

COB Beam angle



Adapter



PHOTOMETRIC

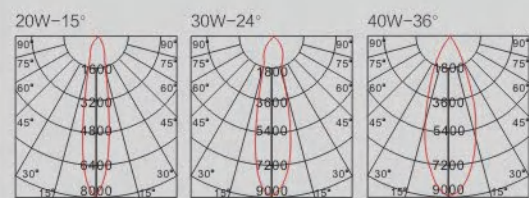

GD19E20A



GD19E30A



GD19E40A

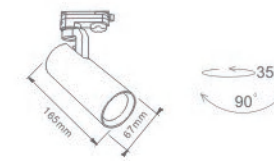

COB 20W

CRI Ra≥80 / Ra≥90
Luminous Flux 1880Lm
Input voltage 180-265VAC/50-60Hz

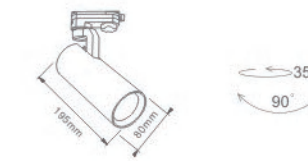

COB 30W

CRI Ra≥80 / Ra≥90
Luminous Flux 2810Lm
Input voltage 180-265VAC/50-60Hz

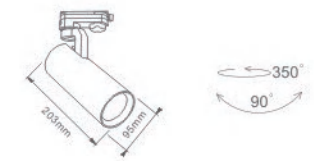

COB 40W

CRI Ra≥80 / Ra≥90
Luminous Flux 3820Lm
Input voltage 180-265VAC/50-60Hz



GD16E40A



OPTIONS

Driver

KGP 科基特 TRIDONIC PHILIPS

A.non-dimmable B.TRIAC
C.1-10V D.DALI

COB

CITIZEN 西村照光 CREE VS LIGHTING SOLUTIONS

3000K 4000K 5000K

Finish

Standard WH
Optional BK

COB Beam angle

15° 24° 36°

Adapter

1-phase (2 wires) 1-phase (3 wires) 3-phase (4 wires)

Adapter driver

COB 40W

CRI Ra≥80 / Ra≥90
Luminous Flux 3560Lm
Input voltage 180-265VAC/50-60Hz

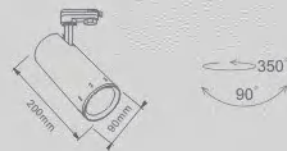

PHOTOMETRIC

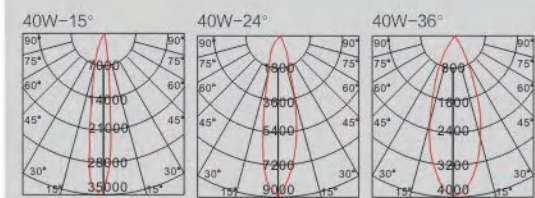



OPTIONS

Driver

KGP 科谷特 TRIDONIC PHILIPS

A.non-dimmable B.TRIAC
C.1-10V D.DALI

COB

CITIZEN 西村照光 CREE VS LIGHTING SOLUTIONS

3000K 4000K 5000K

Finish

Standard WH
Optional BK

COB Beam angle

15° 24° 38°

Adapter

1-phase (2 wires) 1-phase (3 wires) 3-phase (4 wires)

Adapter driver

PHOTOMETRIC

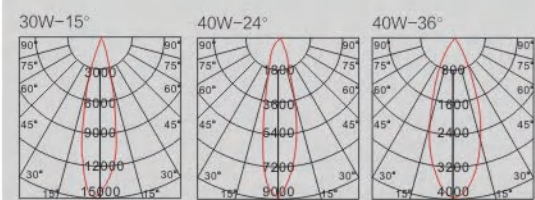

GD19C30A



GD19C40A

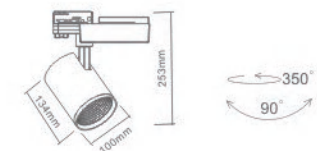
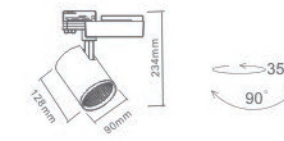

COB 30W

CRI Ra≥80 / Ra≥90
Luminous Flux 2720Lm
Input voltage 180-265VAC/50-60Hz



COB 40W

CRI Ra≥80 / Ra≥90
Luminous Flux 3740Lm
Input voltage 180-265VAC/50-60Hz



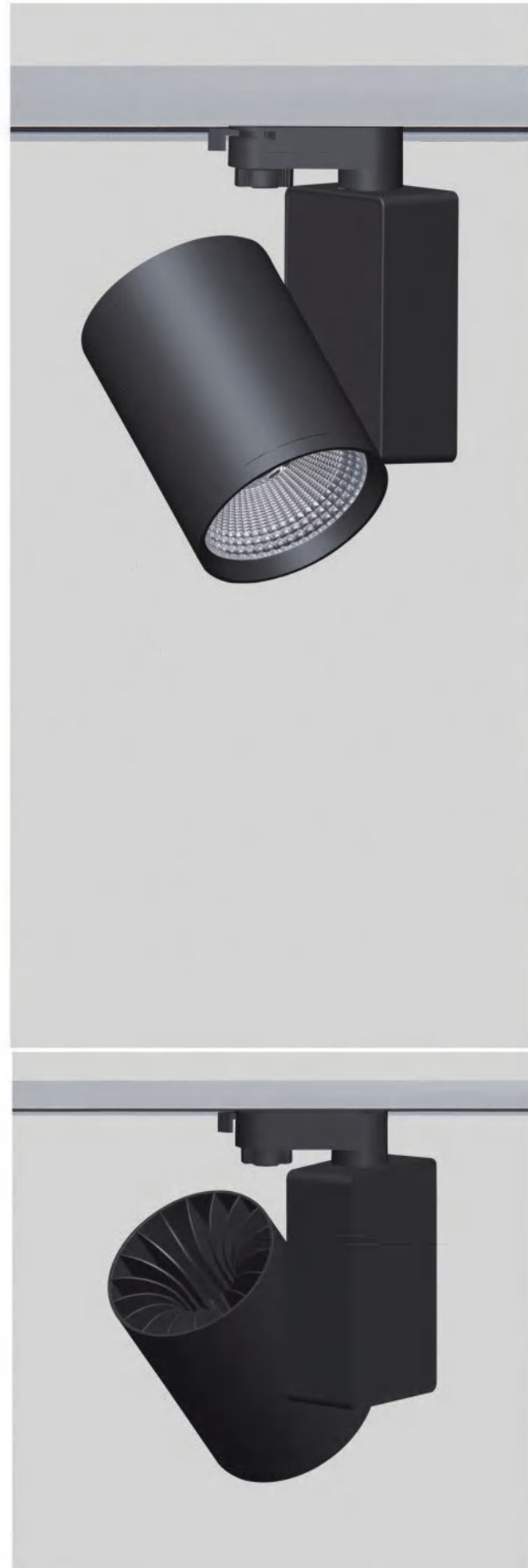

OPTIONS

Driver
 KGP 科谷特 TRIDONIC PHILIPS
 A.non-dimmable B.TRIAC
 C.1-10V D.DALI

COB
 CITIZEN 西村照光 CREE VS LIGHTING SOLUTIONS
 3000K 4000K 5000K

Finish
 Standard WH
 Optional BK

COB Beam angle
 15° 24° 38°

Adapter
 1-phase (2 wires) 1-phase (3 wires) 3-phase (4 wires)

PHOTOMETRIC

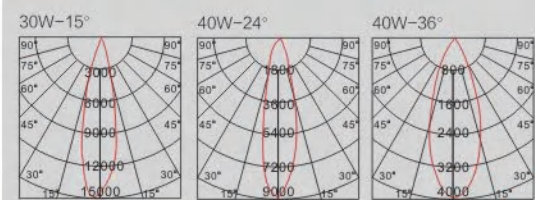

GD19C30C

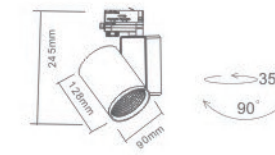

COB 30W

CRI Ra≥80 / Ra≥90
 Luminous Flux 2740Lm
 Input voltage 180-265VAC/50-60Hz



GD19C40C

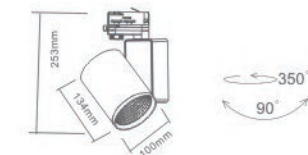

COB 40W

CRI Ra≥80 / Ra≥90
 Luminous Flux 3670Lm
 Input voltage 180-265VAC/50-60Hz



OPTIONS

Driver

KGP 科谷特 TRIDONIC PHILIPS

- A.non-dimmable B.TRIAC
- C.1-10V D.DALI

COB

CITIZEN 西铁城 CREE Cree VS LIGHTING SOLUTIONS

- 3000K ● 4000K ● 5000K

Finish

Standard **WH**

Optional **BK**

COB Beam angle



Adapter



PHOTOMETRIC

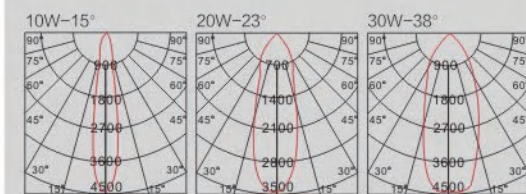

GD19K10A-4

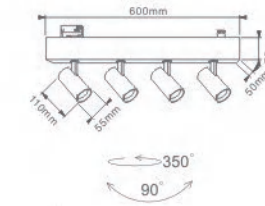
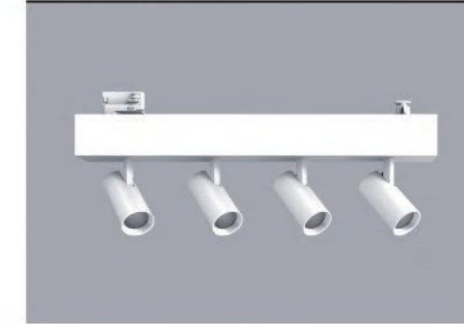

COB 4x10W

CRI Ra≥80 / Ra≥90
Luminous Flux 4x810Lm
Input voltage 180-265VAC/50-60Hz



GD19K20A-4

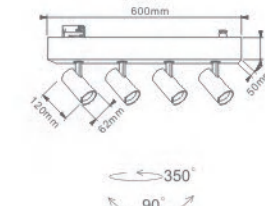
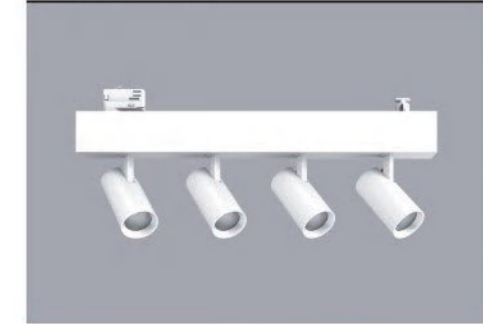

COB 4x20W

CRI Ra≥80 / Ra≥90
Luminous Flux 4x1610Lm
Input voltage 180-265VAC/50-60Hz



GD19K30A-3

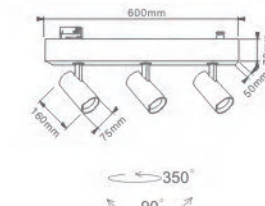
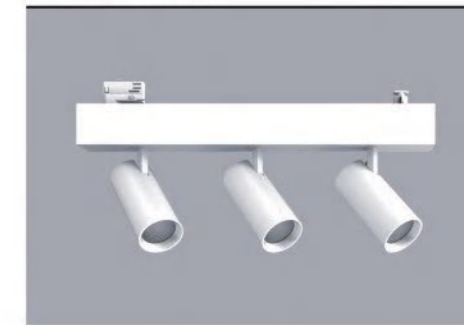

COB 3x30W

CRI Ra≥80 / Ra≥90
Luminous Flux 3x2430Lm
Input voltage 180-265VAC/50-60Hz



GD19K40A-2

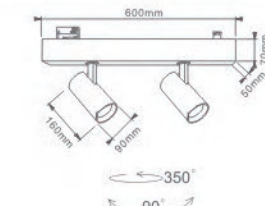
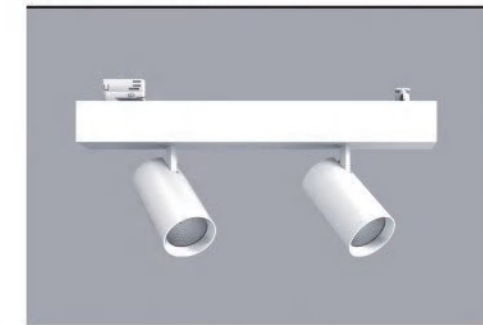

COB 2x40W

CRI Ra≥80 / Ra≥90
Luminous Flux 2x3210Lm
Input voltage 180-265VAC/50-60Hz



OPTIONS

Driver

KGP 科谷特 TRIDONIC PHILIPS

A.non-dimmable B.TRIAC
C.1-10V D.DALI

COB

CITIZEN 邦奇 CREE VS LIGHTING SOLUTIONS

3000K 4000K 5000K

Finish

Standard WH

Optional BK

COB Beam angle



Adapter



Accessory



PHOTOMETRIC

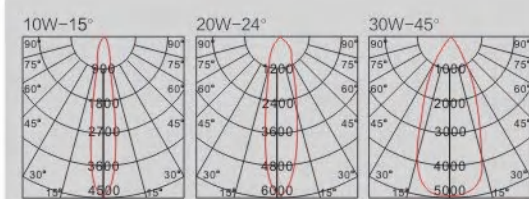

GD18A10C



GD18A20C



GD18A30C

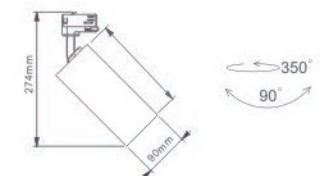
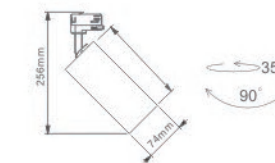
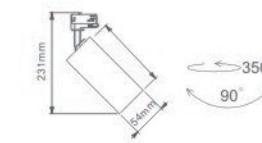

COB 10W

CRI Ra≥80 / Ra≥90
Luminous Flux 810Lm
Input voltage 180-265VAC/50-60Hz



COB 20W

CRI Ra≥80 / Ra≥90
Luminous Flux 1850Lm
Input voltage 180-265VAC/50-60Hz



COB 30W/40W

CRI Ra≥80 / Ra≥90
Luminous Flux 2770Lm / 3810Lm
Input voltage 180-265VAC/50-60Hz





OPTIONS

Driver

KGP 科谷特 TRIDONIC PHILIPS

A.non-dimmable B.TRIAC
C.1-10V D.DALI

COB

CITIZEN 西竹光電 CREE VS LIGHTING SOLUTIONS

3000K 4000K 5000K

Finish

Standard WH
Optional BK

COB Beam angle

15° 24° 36° 45° 60°

Adapter

1-phase (2 wires) 1-phase (3 wires) 3-phase (4 wires)

Adapter driver

Accessory

Black White Gold Honey comb

PHOTOMETRIC

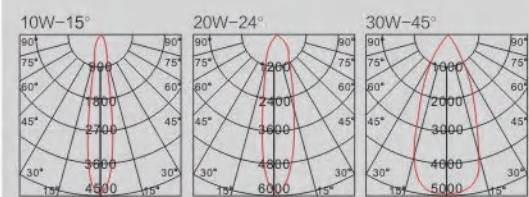

GD18C10A

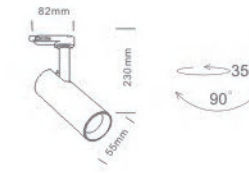

COB 10W

CRI Ra≥80 / Ra≥90
Luminous Flux 820Lm
Input voltage 180-265VAC/50-60Hz



GD18C20A

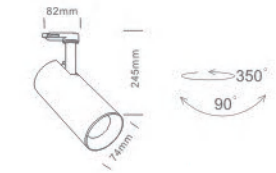

COB 20W

CRI Ra≥80 / Ra≥90
Luminous Flux 1850Lm
Input voltage 180-265VAC/50-60Hz



GD18C30A

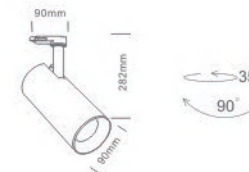

COB 30W

CRI Ra≥80 / Ra≥90
Luminous Flux 2930Lm
Input voltage 180-265VAC/50-60Hz



GD18C40A

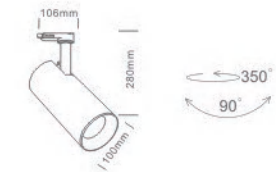

COB 40W

CRI Ra≥80 / Ra≥90
Luminous Flux 3580Lm
Input voltage 180-265VAC/50-60Hz



OPTIONS

Driver

KGP 科谷特 TRIDONIC PHILIPS

A.non-dimmable B.TRIAC
C.1-10V D.DALI

COB

CITIZEN 西村照光 CREE VS LIGHTING SOLUTIONS

3000K 4000K 5000K

Finish

Standard WH

Optional BK

COB Beam angle



Adapter



PHOTOMETRIC

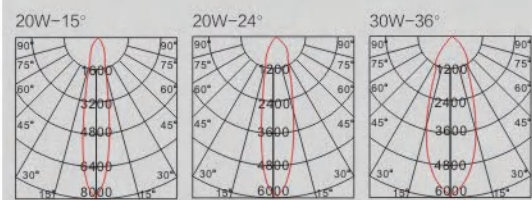

GD18H20B



GD18H30B

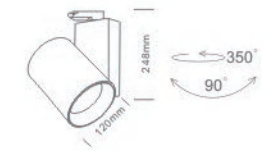
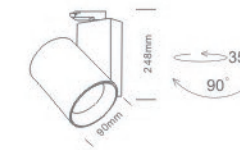

COB 20W

CRI Ra≥80 / Ra≥90
Luminous Flux 1880Lm
Input voltage 180-265VAC/50-60Hz



COB 30W

CRI Ra≥80 / Ra≥90
Luminous Flux 2740Lm
Input voltage 180-265VAC/50-60Hz



OPTIONS

Driver

KGP 科谷特 TRIDONIC PHILIPS

A.non-dimmable B.TRIAC
C.1-10V D.DALI

COB

CITIZEN 西竹光電 HONGLE 宏亮 LED CREE VS LIGHTING SOLUTIONS

3000K 4000K 5000K

Finish

Standard WH

Optional BK

COB Beam angle



Adapter



Accessory



PHOTOMETRIC

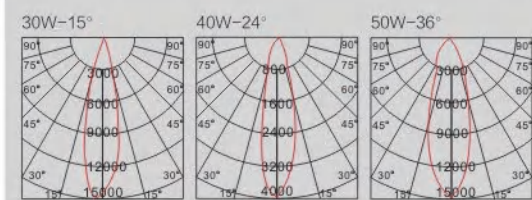

GD18H30A

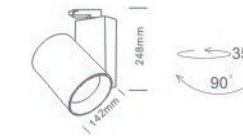

COB 30W

CRI Ra≥80 / Ra≥90
Luminous Flux 2720Lm
Input voltage 180-265VAC/50-60Hz



GD18H40A

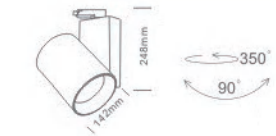

COB 40W

CRI Ra≥80 / Ra≥90
Luminous Flux 3750Lm
Input voltage 180-265VAC/50-60Hz



GD18H50A

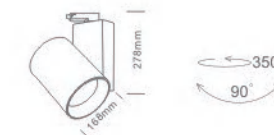

COB 50W

CRI Ra≥80 / Ra≥90
Luminous Flux 4690Lm
Input voltage 180-265VAC/50-60Hz



GD18H60A

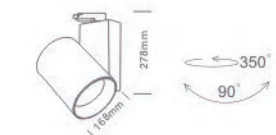

COB 60W

CRI Ra≥80 / Ra≥90
Luminous Flux 5480Lm
Input voltage 180-265VAC/50-60Hz



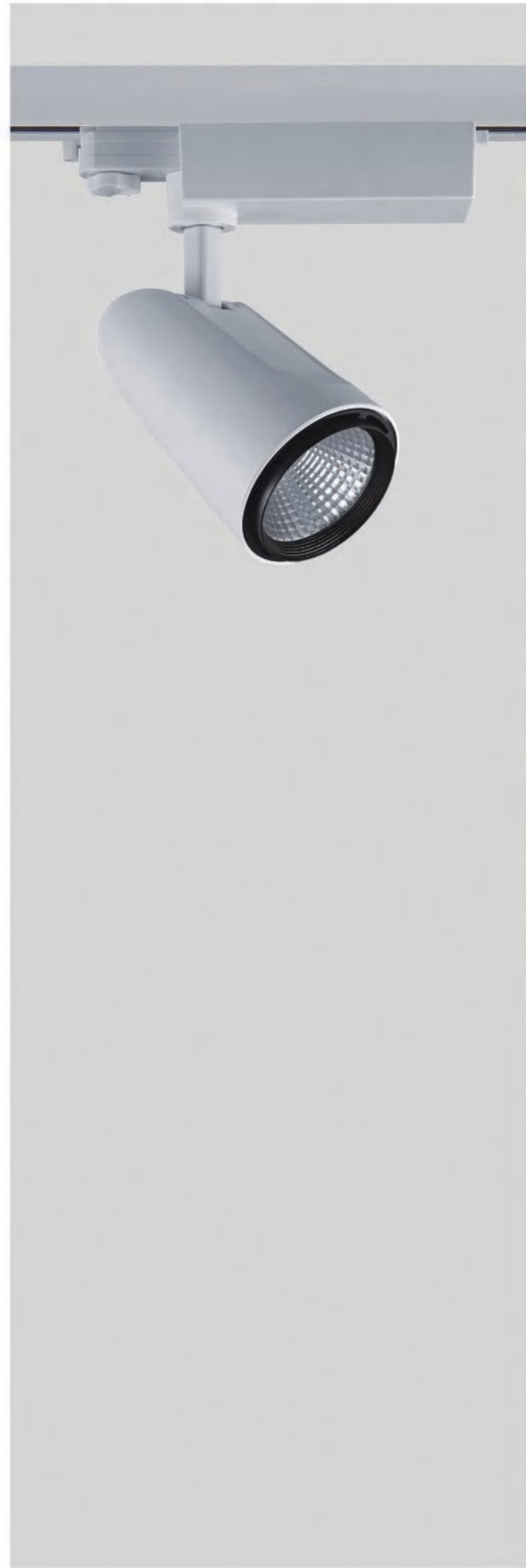

OPTIONS

Driver

KGP 科谷特 TRIDONIC PHILIPS

A.non-dimmable B.TRIAC
C.1-10V D.DALI

COB

CITIZEN 晶锐 CREE VS LIGHTING SOLUTIONS

3000K 4000K 5000K

Finish

Standard WH
Optional BK

COB Beam angle

15° 24° 36° 45° 60°

Adapter

1-phase (2 wires) 3-phase (4 wires)

Adapter driver

PHOTOMETRIC

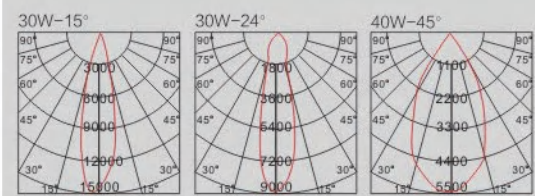

GD17J30C



GD17J40C

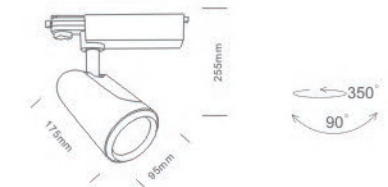
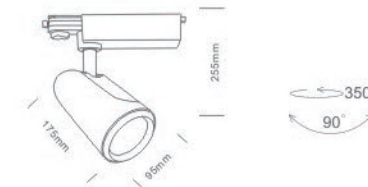

COB 30W

CRI	Ra≥80 / Ra≥90
Luminous Flux	2770Lm
Input voltage	180-265VAC/50-60Hz



COB 40W

CRI	Ra≥80 / Ra≥90
Luminous Flux	3820Lm
Input voltage	180-265VAC/50-60Hz





OPTIONS

Driver
KGP 科谷特 TRIDONIC **PHILIPS**
 A.non-dimmable B.TRIAC
 C.1-10V D.DALI

COB
 CITIZEN 西光 CREE VS LIGHTING SOLUTIONS
 3000K 4000K 5000K

Finish
 Standard WH
 Optional BK

COB Beam angle
 15° 24° 36°

Adapter
 1-phase (2 wires) 1-phase (3 wires) 3-phase (4 wires)
 Adapter driver

Accessory
 Optical lens Honey comb

PHOTOMETRIC
 30W-15° 30W-24° 40W-36°

GD17K30B

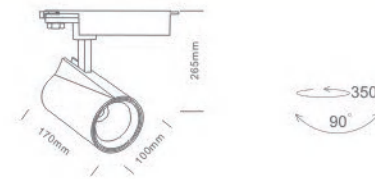

COB 30W

CRI	Ra≥80 / Ra≥90
Luminous Flux	2750Lm
Input voltage	180-265VAC/50-60Hz



GD17K40B

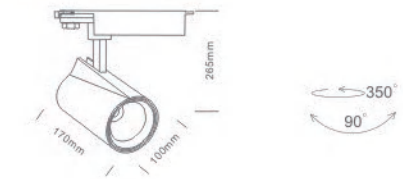

COB 40W

CRI	Ra≥80 / Ra≥90
Luminous Flux	3760Lm
Input voltage	180-265VAC/50-60Hz



GD17K30A

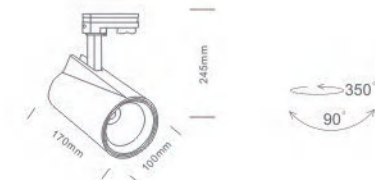

COB 30W

CRI	Ra≥80 / Ra≥90
Luminous Flux	2760Lm
Input voltage	180-265VAC/50-60Hz



GD17K40A

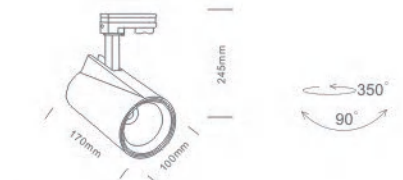

COB 40W

CRI	Ra≥80 / Ra≥90
Luminous Flux	3670Lm
Input voltage	180-265VAC/50-60Hz



OPTIONS

Driver

KGP 科谷特 TRIDONIC PHILIPS

A.non-dimmable B.TRIAC
C.1-10V D.DALI

COB

CITIZEN 西竹光電 HONGLE 宏亮 CREE VS LIGHTING SOLUTIONS

3000K 4000K 5000K

Finish

Standard WH

Optional BK

COB Beam angle



Adapter



Accessory



PHOTOMETRIC

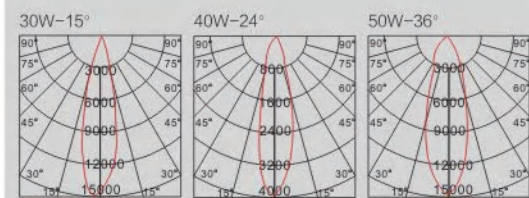

GD16H30C

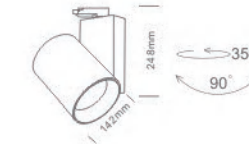

COB 30W

CRI Ra≥80 / Ra≥90
Luminous Flux 2770Lm
Input voltage 180-265VAC/50-60Hz



GD16H40C

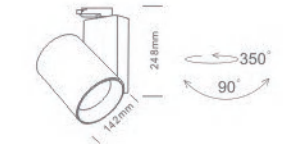

COB 40W

CRI Ra≥80 / Ra≥90
Luminous Flux 3810Lm
Input voltage 180-265VAC/50-60Hz



GD16H50D

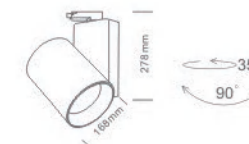

COB 50W

CRI Ra≥80 / Ra≥90
Luminous Flux 4650Lm
Input voltage 180-265VAC/50-60Hz



GD16H60E

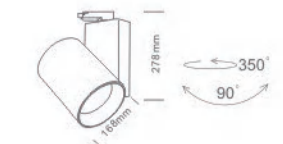

COB 60W

CRI Ra≥80 / Ra≥90
Luminous Flux 5540Lm
Input voltage 180-265VAC/50-60Hz







OPTIONS

Driver	
KGP 科谷特 TRIDONIC PHILIPS	
A.non-dimmable	B.TRIAC
C.1-10V	D.DALI
COB	
CITIZEN 西铁城 HONGCILE 宏利电子 CREE VS LIGHTING SOLUTIONS	
3000K	4000K 5000K
Finish	
Standard WH	
Optional BK	
COB Beam angle	
15°	24° 36°
Adapter	
1-phase (2 wires)	1-phase (3 wires) 3-phase (4 wires)
Accessory	
Honey comb	

PHOTOMETRIC

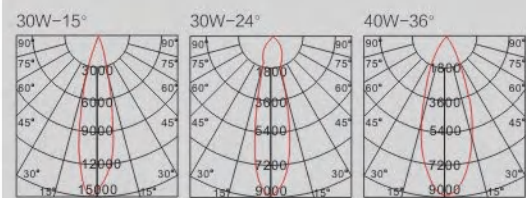

GD16R30A

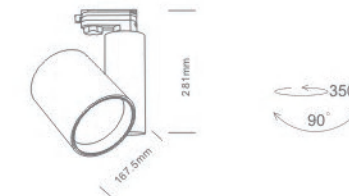

COB 30W

CRI	Ra≥80 / Ra≥90
Luminous Flux	2820Lm
Input voltage	180-265VAC/50-60Hz



GD16R40A

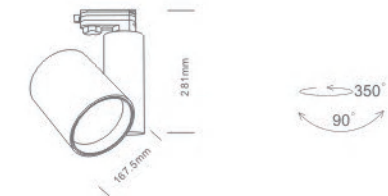

COB 40W

CRI	Ra≥80 / Ra≥90
Luminous Flux	3560Lm
Input voltage	180-265VAC/50-60Hz



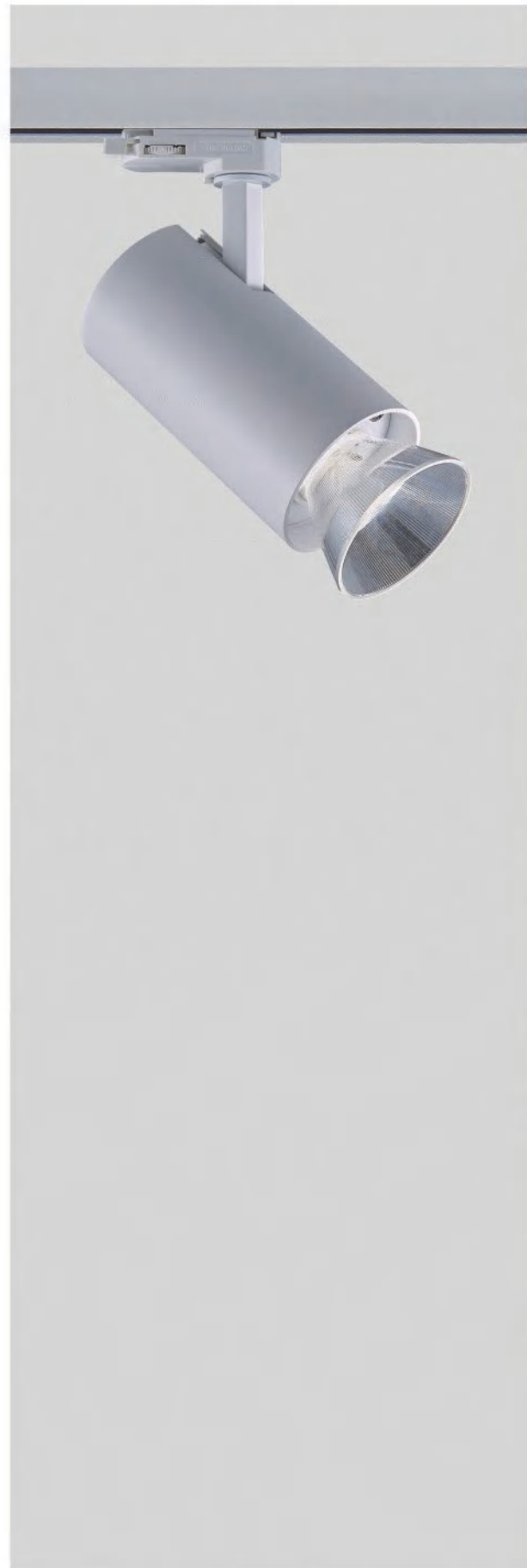

OPTIONS

Driver

KGP 科谷特 TRIDONIC PHILIPS

A.non-dimmable B.TRIAC
C.1-10V D.DALI

COB

CITIZEN 晶锐 CREE VS LIGHTING SOLUTIONS

3000K 4000K 5000K

Finish

Standard WH
Optional BK

COB Beam angle

15° 24° 38°

Adapter

1-phase (2 wires) 1-phase (3 wires) 3-phase (4 wires)

Adapter driver

Accessory

PHOTOMETRIC

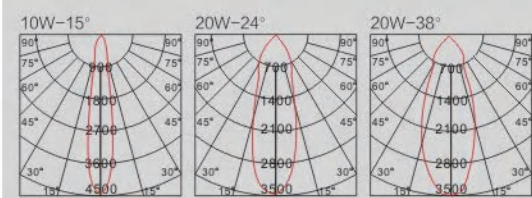

GD17L10B



GD17L20C

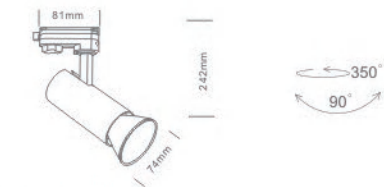
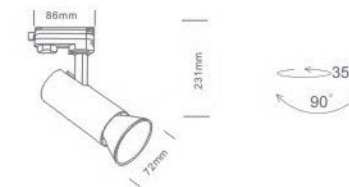

COB 10W

CRI Ra≥80 / Ra≥90
Luminous Flux 810Lm
Input voltage 180-265VAC/50-60Hz



COB 20W

CRI Ra≥80 / Ra≥90
Luminous Flux 1790Lm
Input voltage 180-265VAC/50-60Hz



OPTIONS

Driver

KGP 科谷特 TRIDONIC PHILIPS

A.non-dimmable B.TRIAC
C.1-10V D.DALI

COB

CITIZEN 邦奇 CREE VS LIGHTING SOLUTIONS

3000K 4000K 5000K

Finish

Standard WH

Optional BK

COB Beam angle



Adapter



PHOTOMETRIC

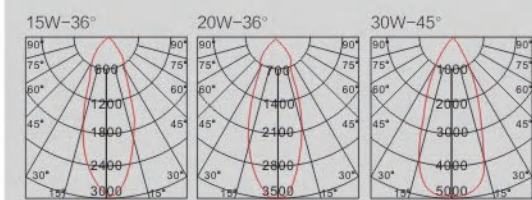

GD18R15A



GD18R20B



GD18R30C

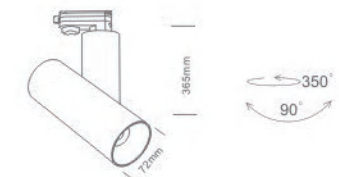
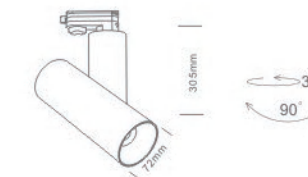
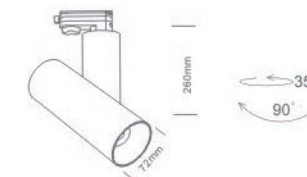

COB 15W

CRI Ra≥80 / Ra≥90
Luminous Flux 1360Lm
Input voltage 180-265VAC/50-60Hz



COB 20W

CRI Ra≥80 / Ra≥90
Luminous Flux 1840Lm
Input voltage 180-265VAC/50-60Hz



COB 30W

CRI Ra≥80 / Ra≥90
Luminous Flux 2710Lm
Input voltage 180-265VAC/50-60Hz





GD16J30A



COB 30W

CRI Ra \geq 80 / Ra \geq 90
 Luminous Flux 2720Lm
 Input voltage 180-265VAC/50-60Hz

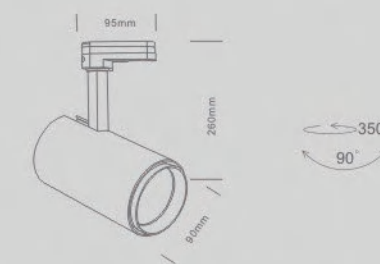

OPTIONS

Driver
 KGP 科名特選 PHILIPS
 A.non-dimmable B.TRIAC
 C.1-10V D.DALI

COB
 CITIZEN 三洋 MINGCE 明思 CREE VS LIGHTING SOLUTIONS
 3000K 4000K 5000K

Finish
 Standard WH
 Optional BK

COB Beam angle



Adapter

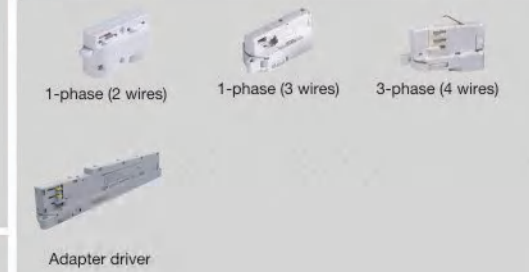

Accessory



PHOTOMETRIC

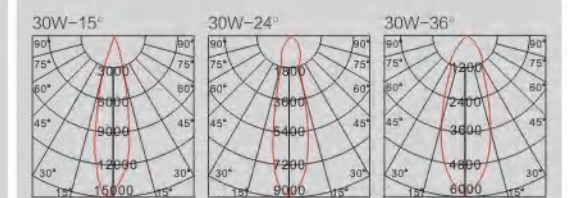



OPTIONS

Driver

KGP 科谷特 TRIDONIC PHILIPS

A.non-dimmable B.TRIAC
C.1-10V D.DALI

COB

CITIZEN 西铁城 CREE Cree VS LIGHTING SOLUTIONS

3000K 4000K 5000K

Finish

Standard WH
Optional BK

COB Beam angle

40W 12° 24° 36° 60°
50W 15° 24° 36°

Adapter

1-phase (2 wires) 1-phase (3 wires) 3-phase (4 wires)

Accessory

Honey comb

PHOTOMETRIC

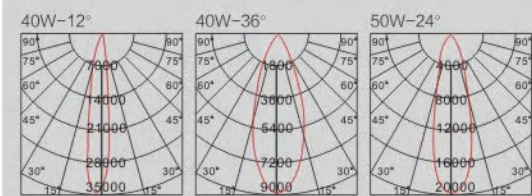

GD16G40C

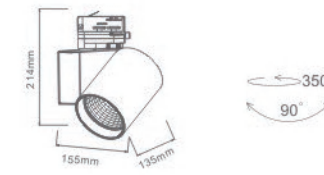

COB 40W

CRI	Ra≥80 / Ra≥90
Luminous Flux	3620Lm
Input voltage	180-265VAC/50-60Hz



GD16G50C

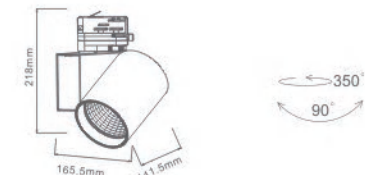

COB 50W

CRI	Ra≥80 / Ra≥90
Luminous Flux	4550Lm
Input voltage	180-265VAC/50-60Hz





OPTIONS

Driver		
KGP 科谷特 TRIDONIC PHILIPS		
A.non-dimmable	B.TRIAC	
C.1-10V	D.DALI	
COB		
CITIZEN 西村洋行 HONGGAI 宏高 CREE VS LIGHTING SOLUTIONS		
3000K	4000K 5000K	
Finish		
Standard	WH	
Optional	BK	
COB Beam angle		
12°	24° 36° 60°	
Adapter		
1-phase (2 wires)	1-phase (3 wires)	3-phase (4 wires)

PHOTOMETRIC

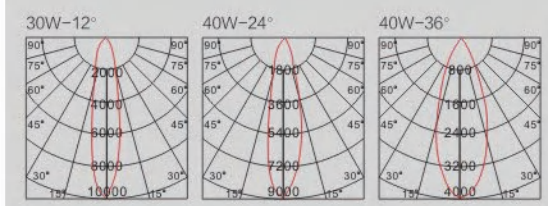

GD16H30A

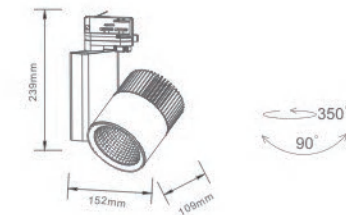

COB 30W

CRI	Ra≥80 / Ra≥90
Luminous Flux	2770Lm
Input voltage	180-265VAC/50-60Hz



GD16H30B

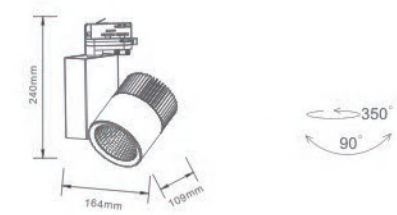

COB 40W

CRI	Ra≥80 / Ra≥90
Luminous Flux	3750Lm
Input voltage	180-265VAC/50-60Hz





OPTIONS

Driver
 KGP 科谷特 TRIDONIC PHILIPS
 A.non-dimmable B.TRIAC
 C.1-10V D.DALI

COB
 CITIZEN 西村照光 CREE VS LIGHTING SOLUTIONS
 3000K 4000K 5000K

Finish
 Standard WH
 Optional BK

COB Beam angle
 12° 24° 36°

Adapter
 1-phase (2 wires) 1-phase (3 wires) 3-phase (4 wires)

PHOTOMETRIC

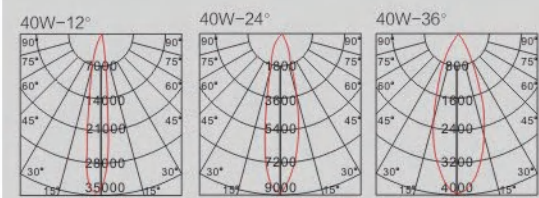

GD16H40A

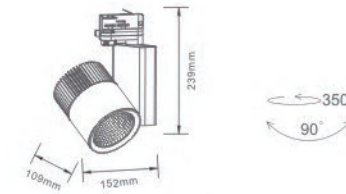

COB 40W

CRI Ra≥80 / Ra≥90
 Luminous Flux 3640Lm
 Input voltage 180-265VAC/50-60Hz



GD16H40B

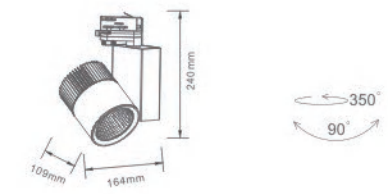

COB 40W

CRI Ra≥80 / Ra≥90
 Luminous Flux 3560Lm
 Input voltage 180-265VAC/50-60Hz



OPTIONS

Driver

KGP 神光特選 TRIDONIC PHILIPS

A.non-dimmable B.TRIAC
C.1-10V D.DALI

COB

CITIZEN 晶元 CREE VS LIGHTING SOLUTIONS

3000K 4000K 5000K

Finish

Standard WH

Optional BK

COB Beam angle



Adapter

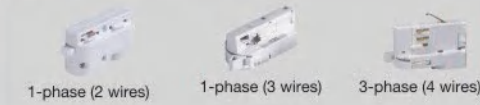

Accessory



PHOTOMETRIC

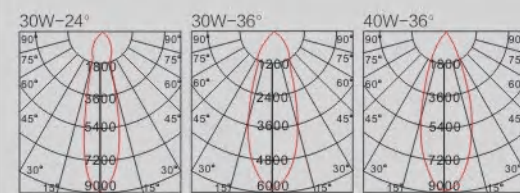

GD16M30A



GD16M40A

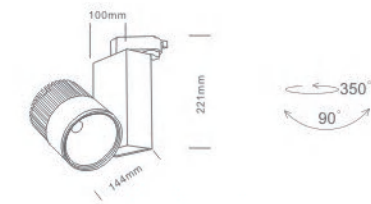
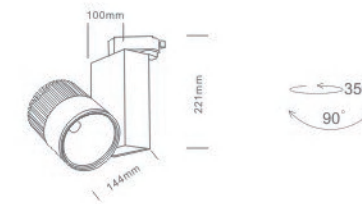

COB 30W

CRI Ra≥80 / Ra≥90
Luminous Flux 2770Lm
Input voltage 180-265VAC/50-60Hz

COB 40W

CRI Ra≥80 / Ra≥90
Luminous Flux 3720Lm
Input voltage 180-265VAC/50-60Hz



OPTIONS

Driver

KGP 科谷特 PHILIPS

A.non-dimmable B.TRIAC
C.1-10V D.DALI

COB

CITIZEN 西村照光 CREE VS LIGHTING SOLUTIONS

3000K 4000K 5000K

Finish

Standard WH
Optional BK

COB Beam angle

10W/20W 12° 24°
30W 15° 24° 36° 45°

Adapter

1-phase (2 wires) 1-phase (3 wires) 3-phase (4 wires)

Adapter driver

Accessory

Reflective cup aluminum

PHOTOMETRIC

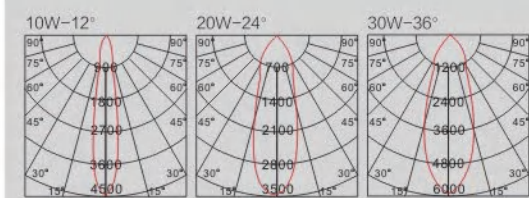

GD16C10A

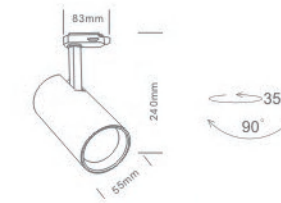

COB 10W

CRI	Ra≥80 / Ra≥90
Luminous Flux	840Lm
Input voltage	180-265VAC/50-60Hz



GD16D20A

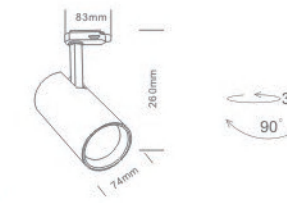

COB 20W

CRI	Ra≥80 / Ra≥90
Luminous Flux	1870Lm
Input voltage	180-265VAC/50-60Hz



GD16E30A

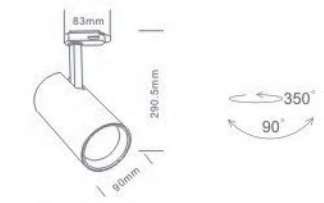

COB 30W

CRI	Ra≥80 / Ra≥90
Luminous Flux	2760Lm
Input voltage	180-265VAC/50-60Hz



OPTIONS

Driver

KGP 科谷特 TRIDONIC PHILIPS

A.non-dimmable B.TRIAC
C.1-10V D.DALI

COB

CITIZEN 西村照光 CREE VS LIGHTING SOLUTIONS

3000K 4000K 5000K

Finish

Standard WH
Optional BK

COB Beam angle

A-30W	12°	24°	36°	60°
C-30W	15°	24°	36°	60°
50W	10°	24°	36°	60°

Adapter

1-phase (2 wires) 1-phase (3 wires) 3-phase (4 wires)

Accessory

Honey comb

PHOTOMETRIC

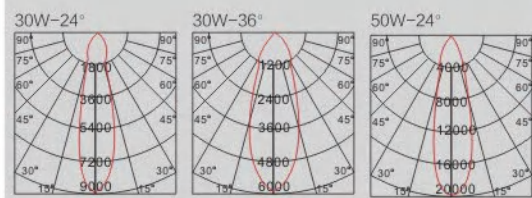

GD16B30A

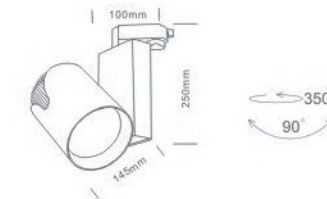

COB 30W

CRI	Ra≥80 / Ra≥90
Luminous Flux	2710Lm
Input voltage	180-265VAC/50-60Hz



GD16B30C

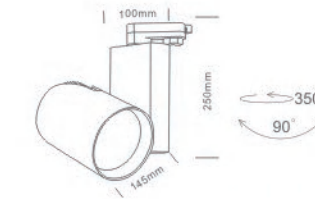

COB 30W

CRI	Ra≥80 / Ra≥90
Luminous Flux	2730Lm
Input voltage	180-265VAC/50-60Hz



GD16B50C

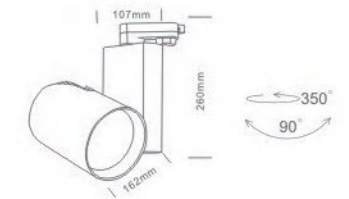

COB 50W

CRI	Ra≥80 / Ra≥90
Luminous Flux	4560Lm
Input voltage	180-265VAC/50-60Hz



GD02F30A

OPTIONS

Driver

KGP 神盾 KGP TRIDONIC PHILIPS

- A.non-dimmable B.TRIAC
- C.1-10V D.DALI

COB

CITIZEN 晶元 CREE VS LIGHTING SOLUTIONS

- 3000K 4000K 5000K

Finish

Standard WH

Optional BK

COB Beam angle

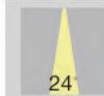

Adapter

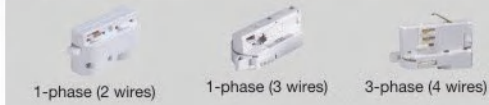

Adapter driver

Accessory



Honey comb

PHOTOMETRIC

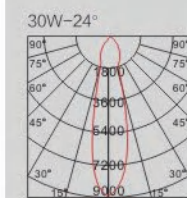

COB 30W

CRI Ra≥80 / Ra≥90
 Luminous Flux 2790Lm
 Input voltage 180-265VAC/50-60Hz

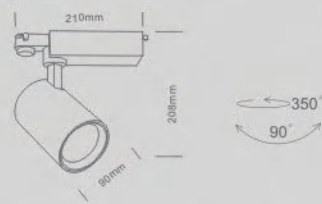

GD15A40A

OPTIONS

Driver

KGP 科锐光源 TRIDONIC PHILIPS

- A.non-dimmable B.TRIAC
- C.1-10V D.DALI

COB

CITIZEN 西谷光源 HONGLI 鸿利智汇 CREE VS LIGHTING SOLUTIONS

- 3000K 4000K 5000K

Finish

Standard WH

Optional BK

COB Beam angle



Adapter



COB 30W/40W

CRI Ra≥80 / Ra≥90
Luminous Flux 2740Lm/3640Lm
Input voltage 180-265VAC/50-60Hz

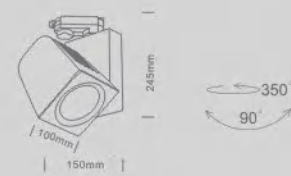

PHOTOMETRIC

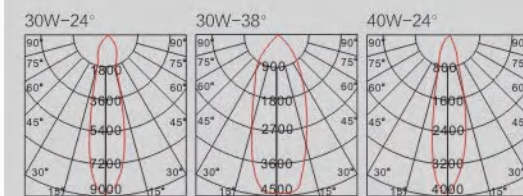

GD15A40C

OPTIONS

Driver

KGP 科锐光源 TRIDONIC PHILIPS

- A.non-dimmable B.TRIAC
- C.1-10V D.DALI

COB

CITIZEN 西谷光源 HONGLI 鸿利智汇 CREE VS LIGHTING SOLUTIONS

- 3000K 4000K 5000K

Finish

Standard WH

Optional BK

COB Beam angle



Adapter

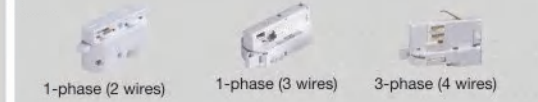

COB 30W/40W

CRI Ra≥80 / Ra≥90
Luminous Flux 2760Lm/3660Lm
Input voltage 180-265VAC/50-60Hz

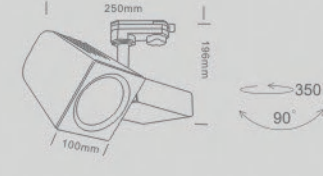

PHOTOMETRIC

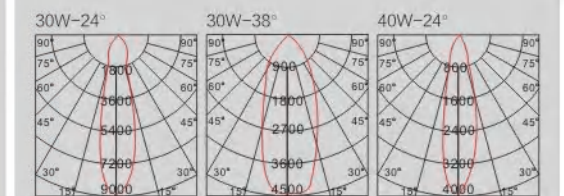



RONSE LIGHTING
MAGNETIC LAMP
SERIES



CX19A12A PAGE 085



CX19B18A PAGE 087



CX19B12B PAGE 089



CX19A05A PAGE 091



CX19B10A PAGE 093

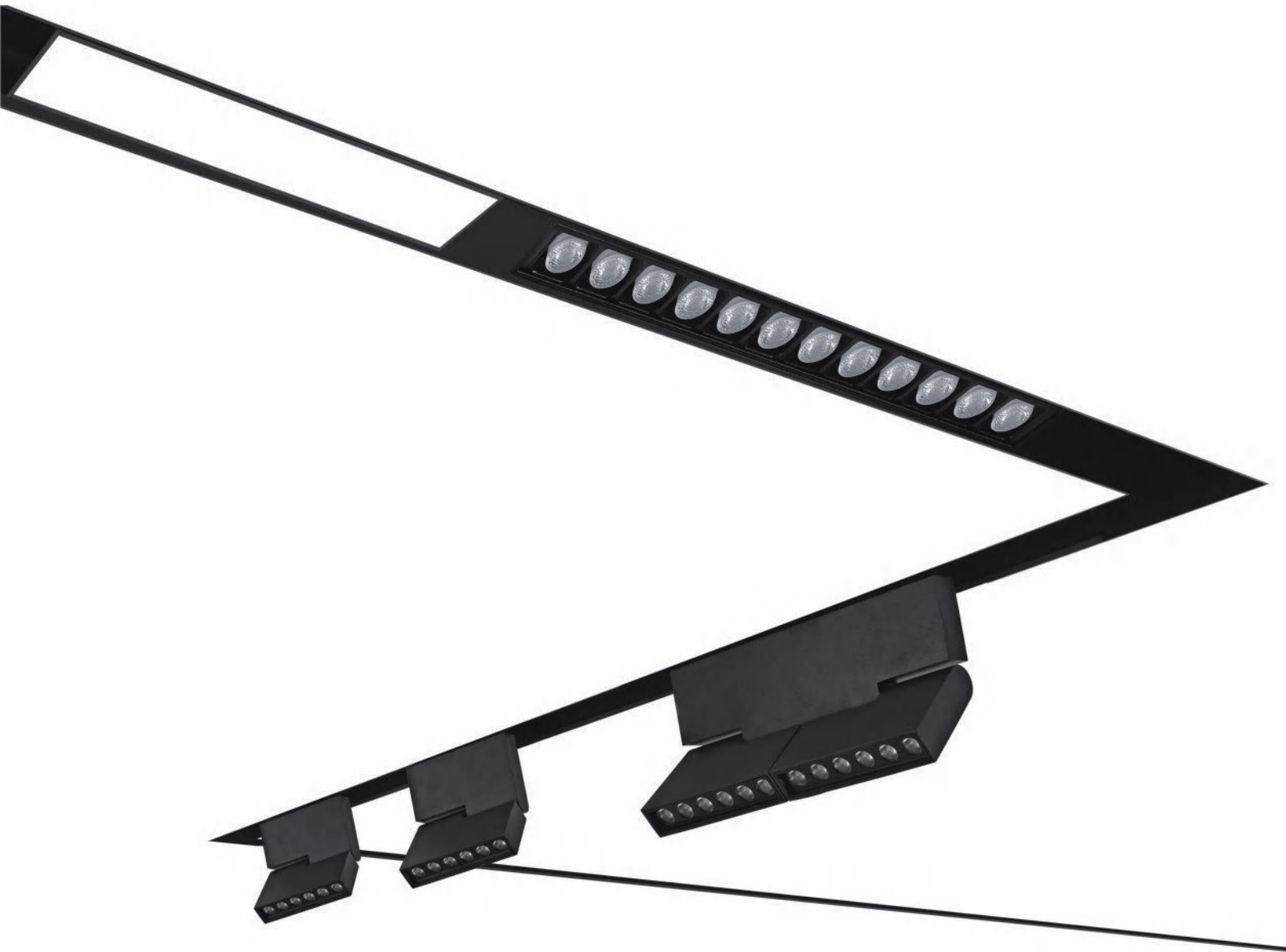

48V Magnetic Track System
 0-10V Dimming
 2.4G Intelligent Dimming
 DALI Dimming

Simple. Fashion. personality

In the future, the mainstream of space lighting will be no main lamp. Simple linear lighting and simple interior decoration will be more and more popular. Simple linear lighting and track magnetic lamp will be the mainstream.

Magnets make life simple

Flexible magnet attachment Different insets are held in place by magnetic force along the entire track. No tools are needed to install them Rotate, slide into any position, and adjust at any time- all it takes is one hand movement to highlight objects according to requirements

Secure click mechanism

Our new locking technology is used in II spots and suspended luminaires. No tools are needed for installation, and spots can be safely released and adjusted and then securely clicked back into place

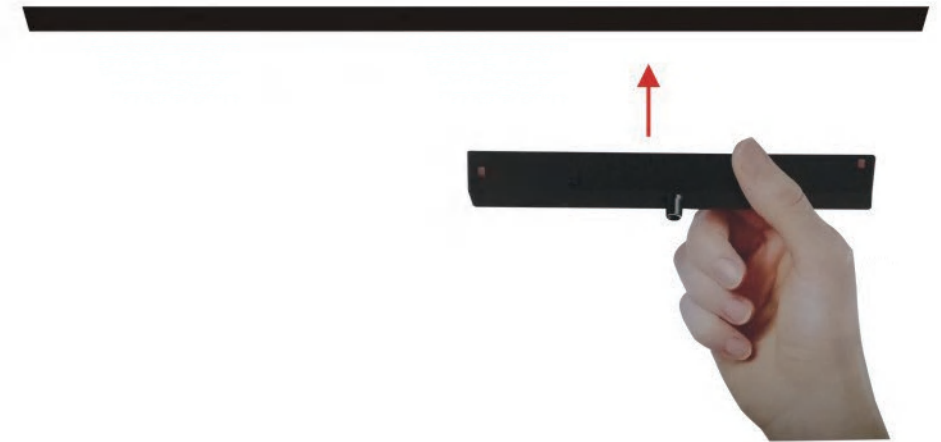

Profile system made of extruded aluminium with 50mm width. Various lighting modules with multiple lighting applications. General light, accent light, wall washer and spotlight module for choice. Tool-free inserts mounting by clip-in mechanism. Standard and customized length of module and cover for high precise system. Magnetic end cap without fixing screws.

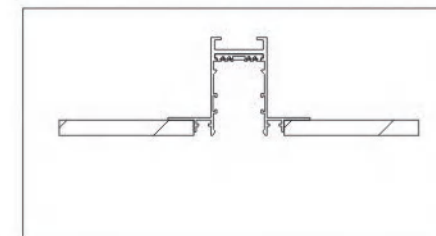
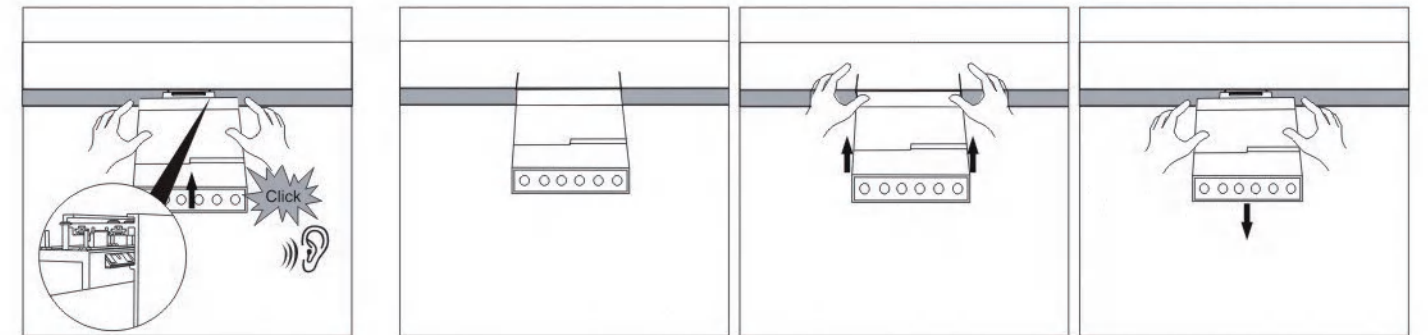

Recessed Installation

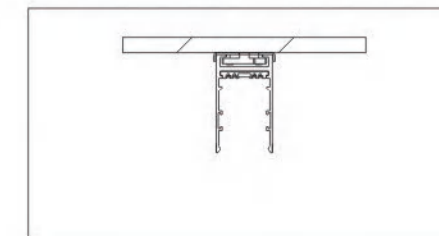

Surface Mounted Installation

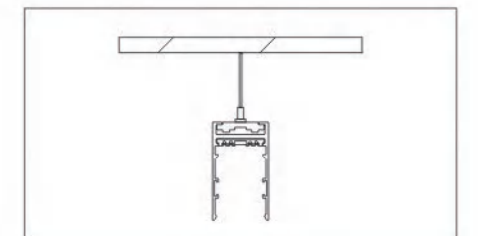

Hanging Installation

OPTIONS

Driver

KGP 科谷智诚 TRIDONIC PHILIPS

- A.non-dimmable B.TRIAC
- C.1-10V D.DALI
- E.Bluetooth

SMD

WORLDSTAR 瀚科智汇 CREE VS LIGHTING SOLUTIONS

- 3000K 4000K 5000K

Finish

Standard WH

Optional BK

SMD Beam angle



CX19A12A

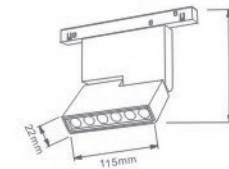

SMD 12W

CRI Ra≥80 / Ra≥90
Luminous Flux 980Lm
Input voltage DC48V



CX19A24A

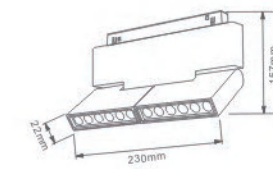

SMD 24W

CRI Ra≥80 / Ra≥90
Luminous Flux 2240Lm
Input voltage DC48V





OPTIONS

Driver

KGP 科谷智誠 TRIDONIC PHILIPS

- A.non-dimmable B.TRIAC
- C.1-10V D.DALI
- E.Bluetooth

SMD

WORLDSTAR 瀚科智光 CREE VS LIGHTING SOLUTIONS

- 3000K ● 4000K ● 5000K

Finish

Standard WH

Optional BK

SMD Beam angle



CX19B18A

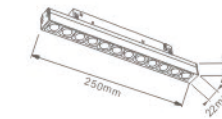
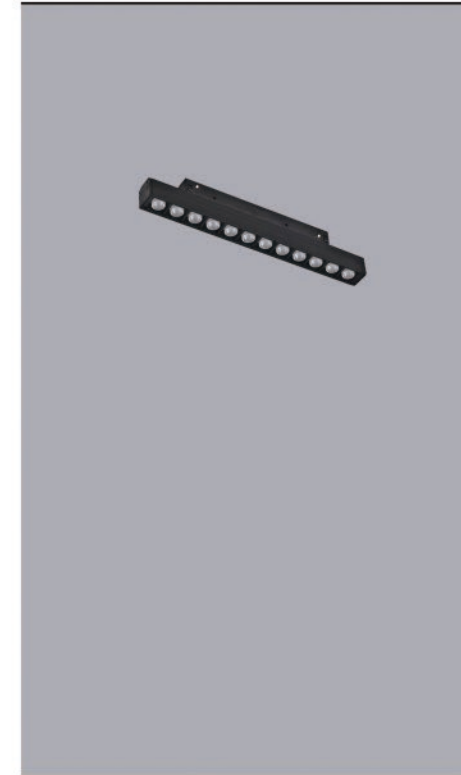

SMD 18W

CRI Ra≥80 / Ra≥90
Luminous Flux 1510Lm
Input voltage DC48V



CX19B36A

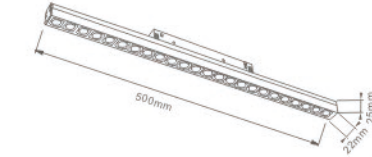
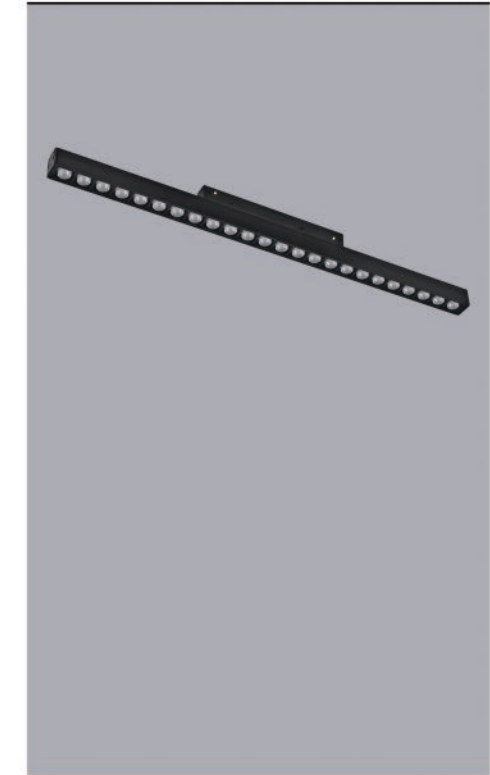

SMD 36W

CRI Ra≥80 / Ra≥90
Luminous Flux 3250Lm
Input voltage DC48V



OPTIONS

Driver

KGP 科普特 TRIDONIC PHILIPS

- A.non-dimmable B.TRIAC
- C.1-10V D.DALI
- E.Bluetooth

SMD

WORLDSTAR 海科星 CREE VS LIGHTING SOLUTIONS

- 3000K 4000K 5000K

Finish

Standard WH

Optional BK

SMD Beam angle

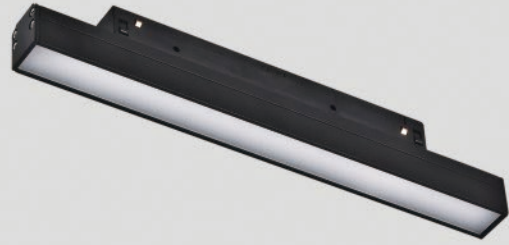

CX19B12B



CX19B24B

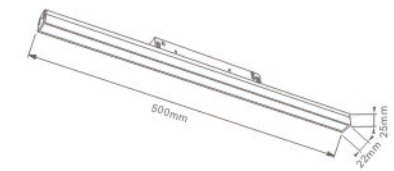
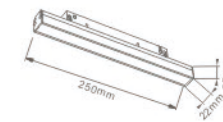
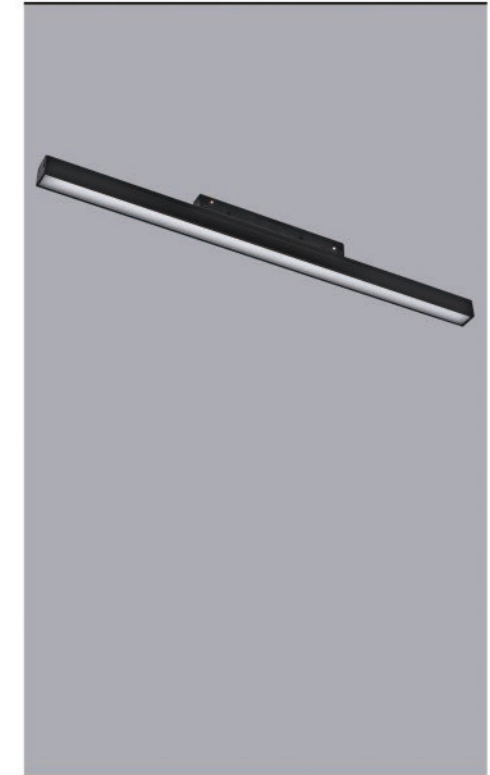

SMD 12W

CRI Ra≥80 / Ra≥90
Luminous Flux 960Lm
Input voltage DC48V



SMD 24W

CRI Ra≥80 / Ra≥90
Luminous Flux 2110Lm
Input voltage DC48V





OPTIONS

Driver

KGP 科普特 TRIDONIC PHILIPS

- A.non-dimmable B.TRIAC
- C.1-10V D.DALI
- E.Bluetooth

COB

CITIZEN Citizen CREE VS LIGHTING SOLUTIONS

- 3000K 4000K 5000K

Finish

Standard WH

Optional BK

COB Beam angle



PHOTOMETRIC

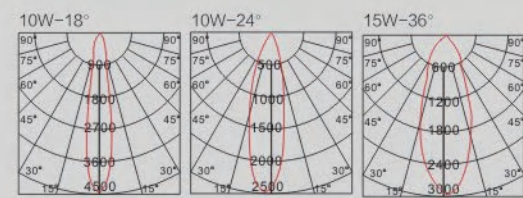

CX19A05A

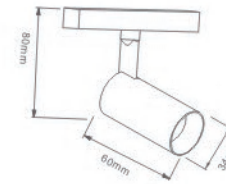
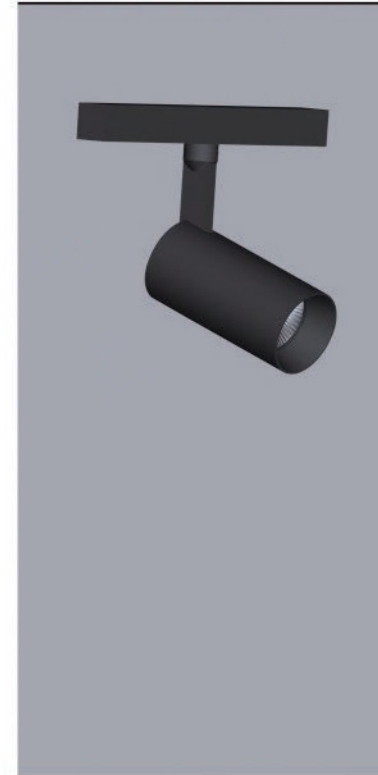

COB 5W

CRI Ra≥80 / Ra≥90
Luminous Flux 360Lm
Input voltage DC48V



CX19A10A

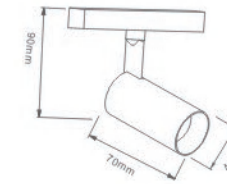
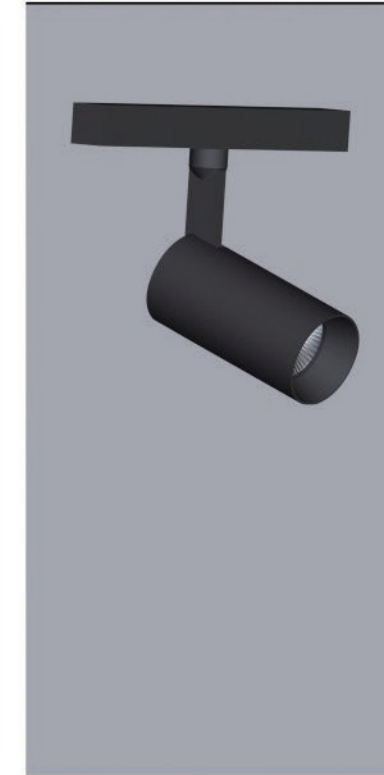

COB 10W

CRI Ra≥80 / Ra≥90
Luminous Flux 720Lm
Input voltage DC48V



CX19A10B

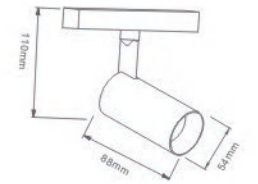

COB 15W

CRI Ra≥80 / Ra≥90
Luminous Flux 1330Lm
Input voltage DC48V





OPTIONS

- Driver**
- KGP 科锐光电 TRIDONIC PHILIPS
- A.non-dimmable B.TRIAC
 C.1-10V D.DALI
 E.Bluetooth
- COB**
- CITIZEN 晶锐 CREE VS LIGHTING SOLUTIONS
- 3000K 4000K 5000K
- Finish**
- Standard WH
 Optional BK
- COB Beam angle**



PHOTOMETRIC

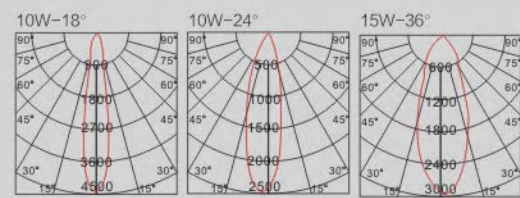

CX19B10A



COB 10W

CRI Ra≥80 / Ra≥90
 Luminous Flux 730Lm
 Input voltage DC48V



CX19B10B

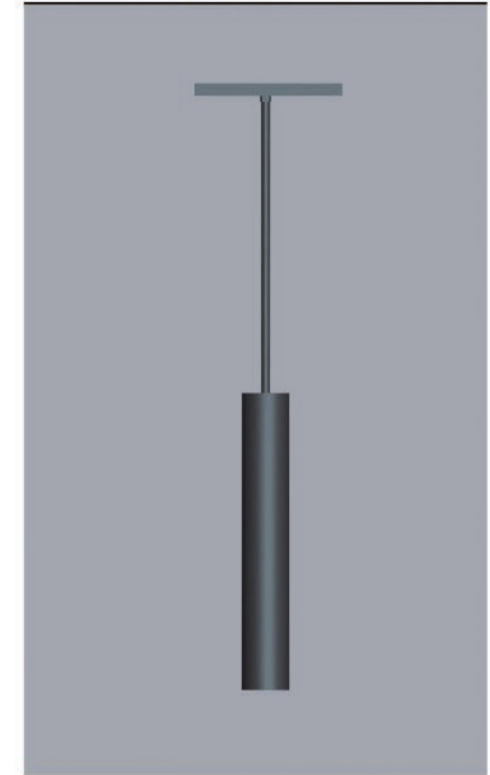

COB 15W

CRI Ra≥80 / Ra≥90
 Luminous Flux 1350Lm
 Input voltage DC48V





RONSE LIGHTING
CEILING LIGHT
SERIES



TH01F05C PAGE 097



TH01B03C PAGE 099

OPTIONS

Driver

KGP 科谷特 TRIDONIC PHILIPS

A.non-dimmable B.TRIAC
C.1-10V D.DALI

COB

CITIZEN 西村洋行 HONGKAI 宏凯 CREE VS LIGHTING SOLUTIONS

3000K 4000K 5000K

Finish

Standard WH

Optional BK

COB Beam angle



PHOTOMETRIC

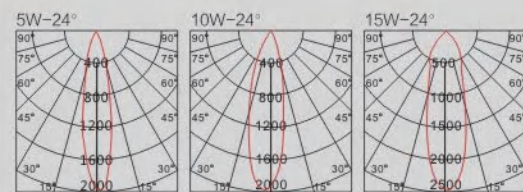

TH01F05C

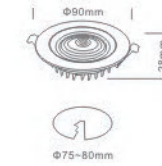

COB 5W

CRI Ra≥80 / Ra≥90
Luminous Flux 360Lm
Input voltage 180-265VAC/50-60Hz



TH02F10C

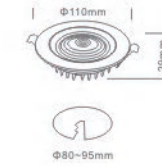

COB 10W

CRI Ra≥80 / Ra≥90
Luminous Flux 810Lm
Input voltage 180-265VAC/50-60Hz



TH03F15C

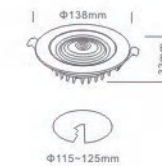
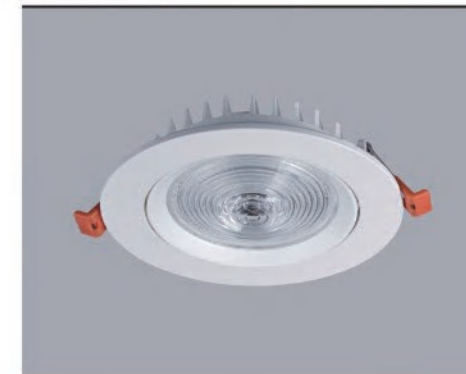

COB 15W

CRI Ra≥80 / Ra≥90
Luminous Flux 1380Lm
Input voltage 180-265VAC/50-60Hz



TH04F20C

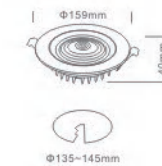
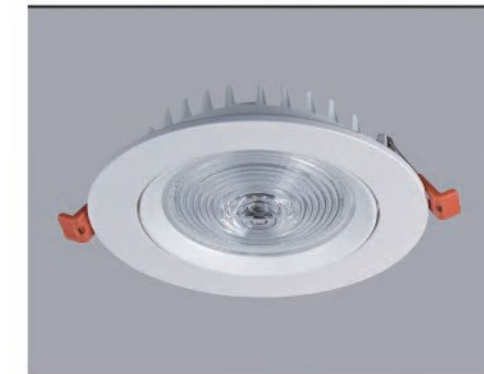

COB 20W

CRI Ra≥80 / Ra≥90
Luminous Flux 1890Lm
Input voltage 180-265VAC/50-60Hz





OPTIONS

Driver

KGP 科谷特 TRIDONIC PHILIPS

- A.non-dimmable B.TRIAC
- C.1-10V D.DALI

COB

CITIZEN 村田 CREE VS LIGHTING SOLUTIONS

- 3000K ● 4000K ● 5000K

Finish

Standard **WH**

Optional **BK**

COB Beam angle



PHOTOMETRIC

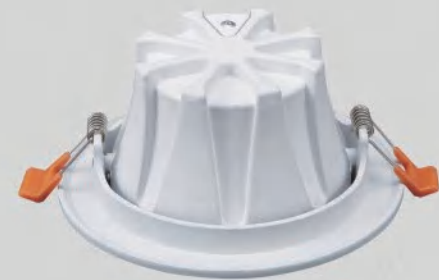
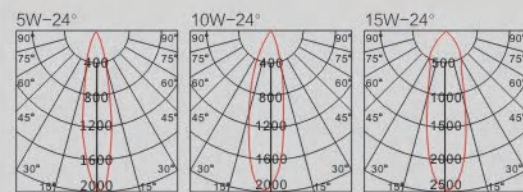

TH01B03C

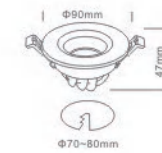

COB 3W

CRI Ra≥80 / Ra≥90
Luminous Flux 230Lm
Input voltage 180-265VAC/50-60Hz



TH01B05C

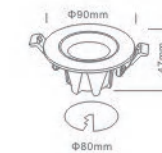

COB 5W

CRI Ra≥80 / Ra≥90
Luminous Flux 340Lm
Input voltage 180-265VAC/50-60Hz



TH02B07C

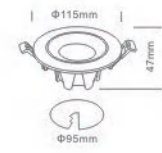

COB 7W

CRI Ra≥80 / Ra≥90
Luminous Flux 590Lm
Input voltage 180-265VAC/50-60Hz



TH02B10C

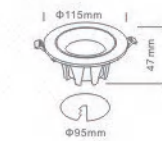

COB 10W

CRI Ra≥80 / Ra≥90
Luminous Flux 830Lm
Input voltage 180-265VAC/50-60Hz



TH03B15C

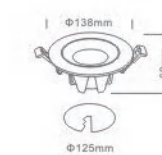

COB 15W

CRI Ra≥80 / Ra≥90
Luminous Flux 1360Lm
Input voltage 180-265VAC/50-60Hz





RONSE LIGHTING
DOWNLIGHT
SERIES



TD04M24C PAGE 103



TD04K20C PAGE 105



TD25C05S PAGE 107



TD25H05C PAGE 109



TD25H05S PAGE 111



RS-T610C PAGE 113



RS-T107C PAGE 115

TD04M24C



OPTIONS

Driver

AI Dimming®

- A.non-dimmable B.TRIAC
- C.1-10V D.DALI

COB

- CITIZEN
- 3000K ● 4000K ● 5000K

Finish

- Standard WH
- Optional BK

COB Beam angle



COB 10W+Audio 5W(Single lamp)

- CRI Ra≥80 / Ra≥90
- Luminous Flux 820Lm
- Input voltage 180-265VAC/50-60Hz



PHOTOMETRIC

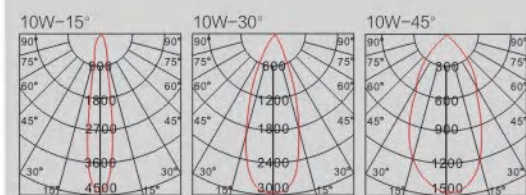

MUSIC DOWNLIGHT

Bluetooth 4.0 high speed connection
Online resources are unobstructed

amazon echo

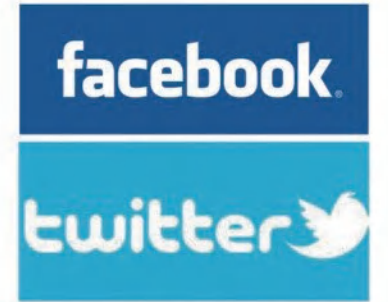

TWO PCS AS ONE GROUP ,
 MAXIMUM CONNECTION IS EIGHT GROUPS





OPTIONS

Driver

KGP 科谷特 TRIDONIC PHILIPS

A.non-dimmable B.TRIAC
C.1-10V D.DALI

COB

CITIZEN 晶元 CREE VS LIGHTING SOLUTIONS

3000K 4000K 5000K

Finish

Standard WH

Optional BK

COB Beam angle



PHOTOMETRIC

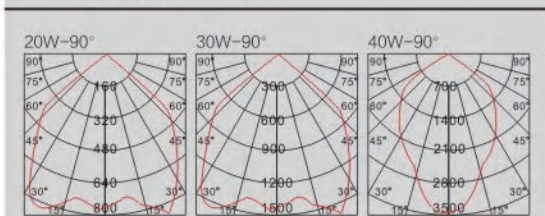

TD04K20C



COB 20W

CRI Ra ≥ 80 / Ra ≥ 90
Luminous Flux 1790Lm
Input voltage 180-265VAC/50-60Hz



TD06K30C



COB 30W

CRI Ra ≥ 80 / Ra ≥ 90
Luminous Flux 2760Lm
Input voltage 180-265VAC/50-60Hz



TD08K40C



COB 40W

CRI Ra ≥ 80 / Ra ≥ 90
Luminous Flux 3620Lm
Input voltage 180-265VAC/50-60Hz



TD08K60C



COB 60W

CRI Ra ≥ 80 / Ra ≥ 90
Luminous Flux 5320Lm
Input voltage 180-265VAC/50-60Hz





OPTIONS

Driver

KGP 科谷特 TRIDONIC PHILIPS

A.non-dimmable B.TRIAC
C.1-10V D.DALI

SMD

CITIZEN 村田 CREE VS LIGHTING SOLUTIONS

3000K 4000K 5000K

Finish

Standard WH
Optional BK

SMD Beam angle

90°

PHOTOMETRIC

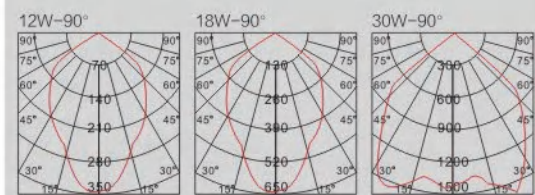

TD25C05S

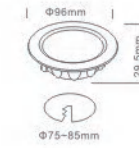

SMD 5W

CRI Ra \geq 80 / Ra \geq 90
Luminous Flux 340Lm
Input voltage 180-265VAC/50-60Hz



TD03C07S

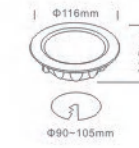
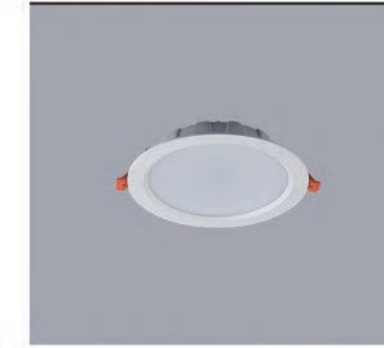

SMD 7W

CRI Ra \geq 80 / Ra \geq 90
Luminous Flux 480Lm
Input voltage 180-265VAC/50-60Hz



TD04C12S

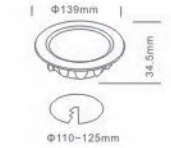

SMD 12W

CRI Ra \geq 80 / Ra \geq 90
Luminous Flux 950Lm
Input voltage 180-265VAC/50-60Hz



TD06C18S

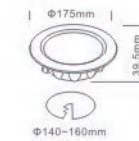

SMD 18W

CRI Ra \geq 80 / Ra \geq 90
Luminous Flux 1420Lm
Input voltage 180-265VAC/50-60Hz



TD08C25S

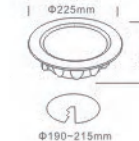

SMD 25W

CRI Ra \geq 80 / Ra \geq 90
Luminous Flux 2320Lm
Input voltage 180-265VAC/50-60Hz



TD08C30S

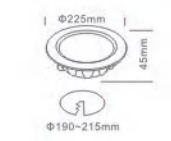

SMD 30W

CRI Ra \geq 80 / Ra \geq 90
Luminous Flux 2710Lm
Input voltage 180-265VAC/50-60Hz





OPTIONS

Driver

KGP 科谷特 TRIDONIC PHILIPS

- A.non-dimmable B.TRIAC
- C.1-10V D.DALI

COB

CITIZEN 西村照光 CREE VS LIGHTING SOLUTIONS

- 3000K ● 4000K ● 5000K

Finish

Standard **WH**

Optional **BK**

COB Beam angle

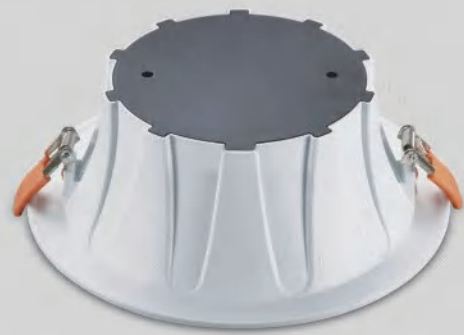

PHOTOMETRIC

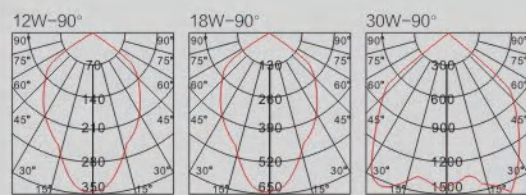

TD25H05C

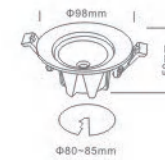

COB 5W

CRI Ra≥80 / Ra≥90
Luminous Flux 380Lm
Input voltage 180-265VAC/50-60Hz



TD35H07C

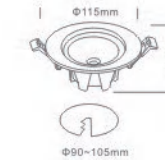

COB 7W

CRI Ra≥80 / Ra≥90
Luminous Flux 510Lm
Input voltage 180-265VAC/50-60Hz



TD04H12C

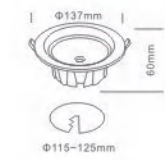

COB 12W

CRI Ra≥80 / Ra≥90
Luminous Flux 980Lm
Input voltage 180-265VAC/50-60Hz



TD06H20C

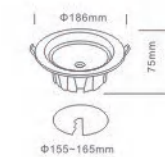

COB 18W

CRI Ra≥80 / Ra≥90
Luminous Flux 1380Lm
Input voltage 180-265VAC/50-60Hz



TD08H25C



COB 25W

CRI Ra≥80 / Ra≥90
Luminous Flux 2360Lm
Input voltage 180-265VAC/50-60Hz



TD08H30C

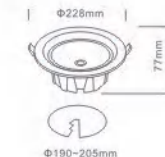

COB 30W

CRI Ra≥80 / Ra≥90
Luminous Flux 2690Lm
Input voltage 180-265VAC/50-60Hz



OPTIONS

Driver

KGP 科谷特 TRIDONIC PHILIPS

A.non-dimmable B.TRIAC
C.1-10V D.DALI

SMD

CITIZEN 晶元 CREE VS LIGHTING SOLUTIONS

3000K 4000K 5000K

Finish

Standard WH

Optional BK

SMD Beam angle



PHOTOMETRIC

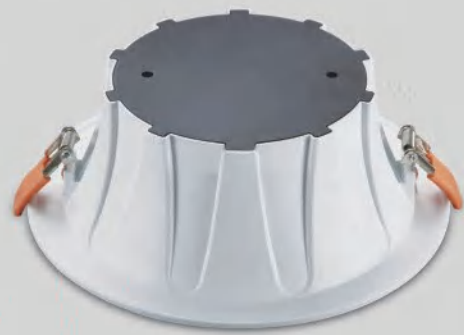
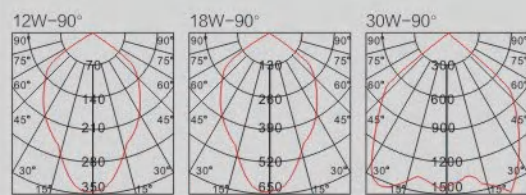

TD25H05S

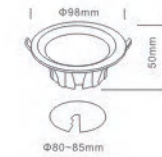

SMD 5W

CRI Ra ≥ 80 / Ra ≥ 90
Luminous Flux 320Lm
Input voltage 180-265VAC/50-60Hz



TD035H07S

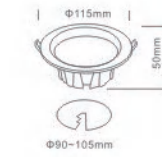

SMD 7W

CRI Ra ≥ 80 / Ra ≥ 90
Luminous Flux 450Lm
Input voltage 180-265VAC/50-60Hz



TD04H12S

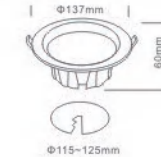

SMD 12W

CRI Ra ≥ 80 / Ra ≥ 90
Luminous Flux 920Lm
Input voltage 180-265VAC/50-60Hz



TD06H18S

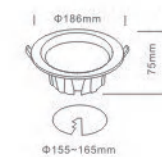

SMD 18W

CRI Ra ≥ 80 / Ra ≥ 90
Luminous Flux 1390Lm
Input voltage 180-265VAC/50-60Hz



TD08H25S

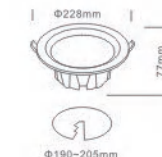

SMD 25W

CRI Ra ≥ 80 / Ra ≥ 90
Luminous Flux 2310Lm
Input voltage 180-265VAC/50-60Hz



TD08H30S

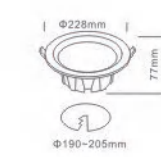

SMD 30W

CRI Ra ≥ 80 / Ra ≥ 90
Luminous Flux 2670Lm
Input voltage 180-265VAC/50-60Hz



OPTIONS

Driver

KGP 科谷特 TRIDONIC PHILIPS

- A.non-dimmable B.TRIAC
- C.1-10V D.DALI

COB

CITIZEN 西铁城 CREE Cree VS LIGHTING SOLUTIONS

- 3000K 4000K 5000K

Finish

Standard WH

Optional BK

COB Beam angle



PHOTOMETRIC

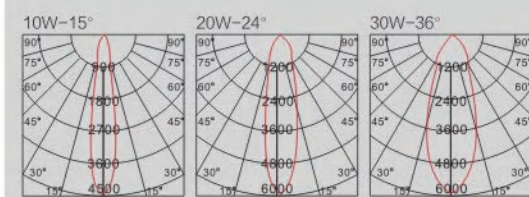

RS-T610C

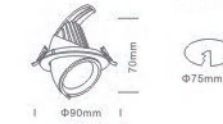

COB 10W

CRI Ra≥80 / Ra≥90
Luminous Flux 790Lm
Input voltage 180-265VAC/50-60Hz



RS-T620C

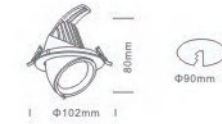

COB 20W

CRI Ra≥80 / Ra≥90
Luminous Flux 1840Lm
Input voltage 180-265VAC/50-60Hz



RS-T630C



COB 30W

CRI Ra≥80 / Ra≥90
Luminous Flux 2760Lm
Input voltage 180-265VAC/50-60Hz



RS-T640C

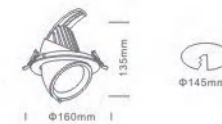

COB 40W

CRI Ra≥80 / Ra≥90
Luminous Flux 3640Lm
Input voltage 180-265VAC/50-60Hz



OPTIONS

Driver

KGP 科谷特 TRIDONIC PHILIPS

- A.non-dimmable B.TRIAC
- C.1-10V D.DALI

COB

CITIZEN 晶元 CREE VS LIGHTING SOLUTIONS

- 3000K ● 4000K ● 5000K

Finish

Standard **WH**

Optional **BK**

COB Beam angle



PHOTOMETRIC

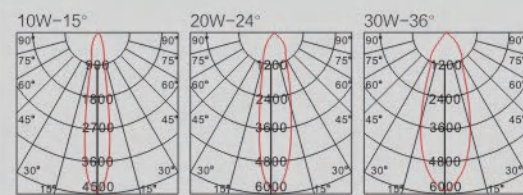

RS-T107C

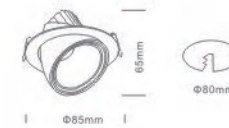

COB 7W

CRI Ra≥80 / Ra≥90
Luminous Flux 460Lm
Input voltage 180-265VAC/50-60Hz



RS-T210C

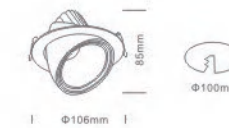

COB 10W

CRI Ra≥80 / Ra≥90
Luminous Flux 810Lm
Input voltage 180-265VAC/50-60Hz



RS-T320C

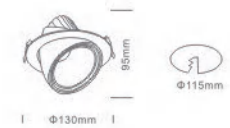

COB 20W

CRI Ra≥80 / Ra≥90
Luminous Flux 1810Lm
Input voltage 180-265VAC/50-60Hz



RS-T430C

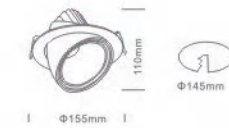

COB 30W

CRI Ra≥80 / Ra≥90
Luminous Flux 2880Lm
Input voltage 180-265VAC/50-60Hz



RS-T540C

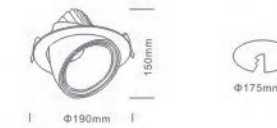

COB 40W

CRI Ra≥80 / Ra≥90
Luminous Flux 4220Lm
Input voltage 180-265VAC/50-60Hz





RONSE LIGHTING
SPOT LIGHT
SERIES



WL18B12D PAGE 119



RS-2117A PAGE 121



WL18C15A PAGE 123



WL18C30B PAGE 123



WL18C45C PAGE 123



WL18A10A PAGE 125

WL18B12D



OPTIONS

Driver

KGP 科谷特 TRIDONIC PHILIPS

- A.non-dimmable B.TRIAC
- C.1-10V D.DALI

COB

CITIZEN 西村洋行 CREE VS LIGHTING SOLUTIONS

- 3000K 4000K 5000K

Finish

Standard WH

Optional BK

COB Beam angle



COB 12W

CRI Ra≥80 / Ra≥90
 Luminous Flux 970Lm
 Input voltage 180-265VAC/50-60Hz

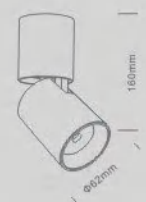
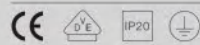

PHOTOMETRIC

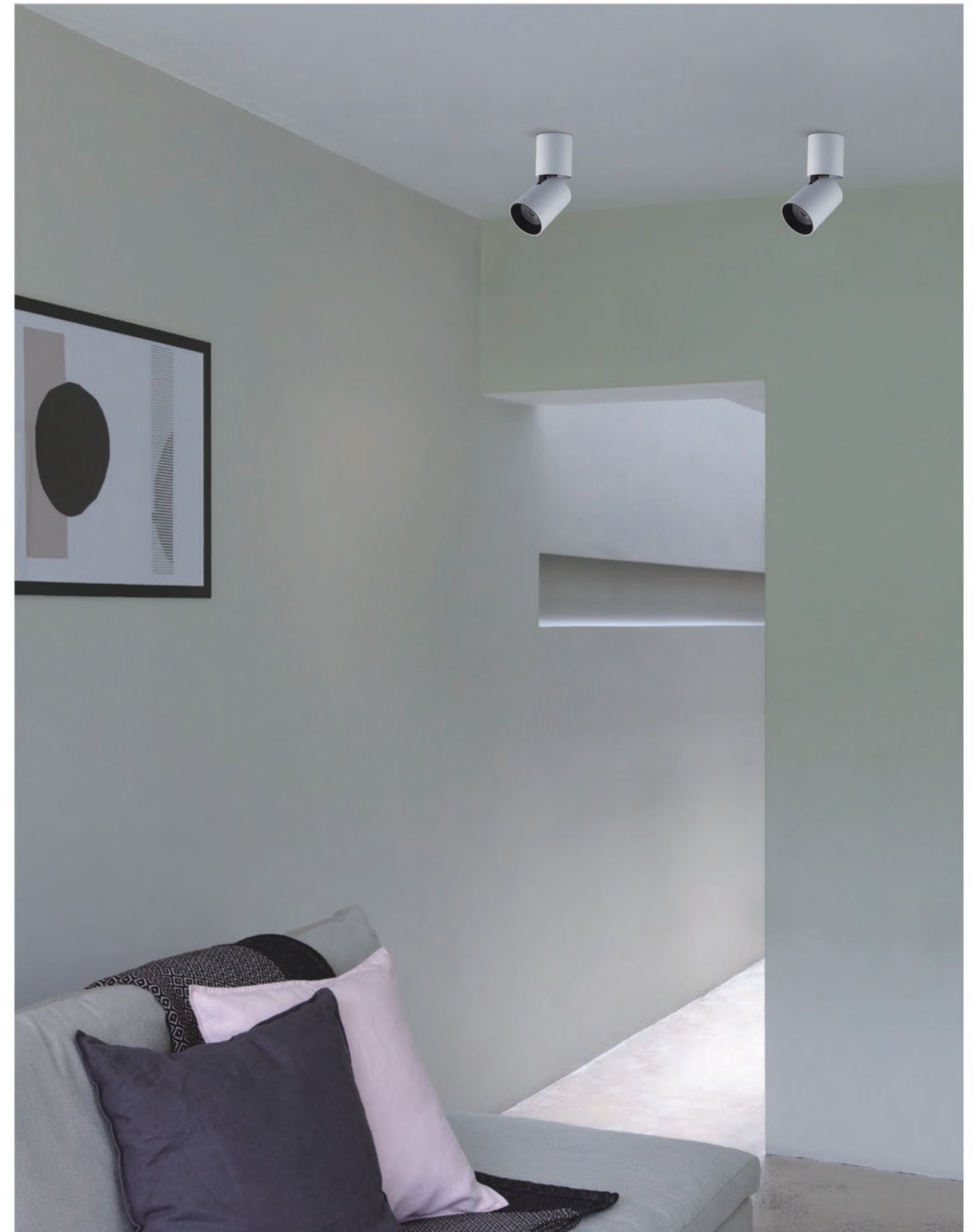
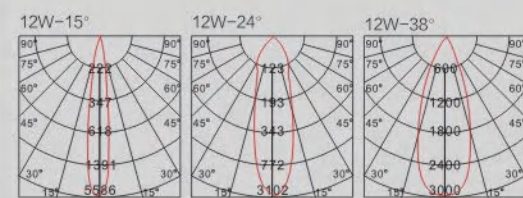



OPTIONS

Driver

KGP 科谷特 TRIDONIC PHILIPS

- A.non-dimmable B.TRIAC
- C.1-10V D.DALI

COB

CITIZEN 西村洋行 CREE VS LIGHTING SOLUTIONS

- 3000K ● 4000K ● 5000K

Finish

Standard WH

Optional BK

COB Beam angle



PHOTOMETRIC

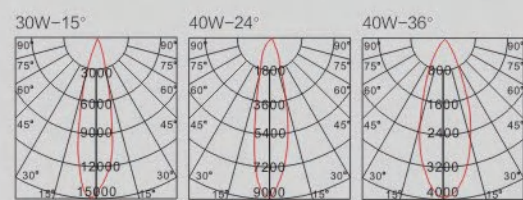

RS-2117A

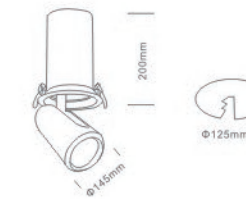

COB 30W

CRI Ra≥80 / Ra≥90
 Luminous Flux 2750Lm
 Input voltage 180-265VAC/50-60Hz



RS-2117A

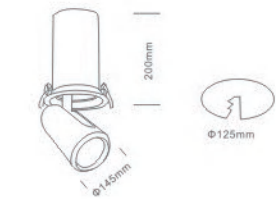

COB 40W

CRI Ra≥80 / Ra≥90
 Luminous Flux 3720Lm
 Input voltage 180-265VAC/50-60Hz



OPTIONS

Driver

KGP 科谷特 TRIDONIC PHILIPS

- A.non-dimmable B.TRIAC
- C.1-10V D.DALI

COB

CITIZEN 西村照子 CREE VS LIGHTING SOLUTIONS

- 3000K 4000K 5000K

Finish

Standard WH

Optional BK

COB Beam angle



Accessory



Reflective cup aluminum

PHOTOMETRIC

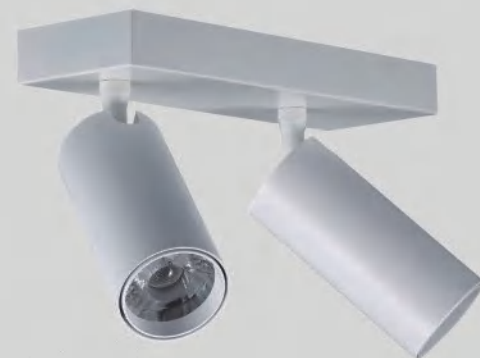
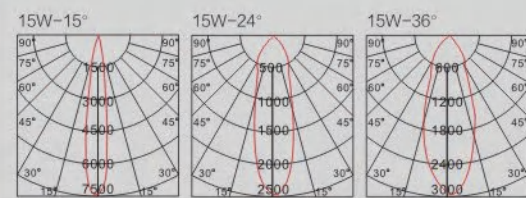

WL18C15A



WL18C30B



WL18C45C

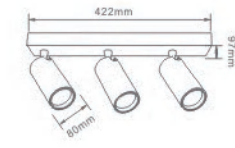
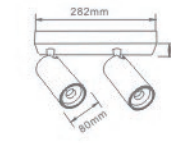

COB 15W

CRI Ra≥80 / Ra≥90
Luminous Flux 1340Lm
Input voltage 180-265VAC/50-60Hz



COB 2x15W

CRI Ra≥80 / Ra≥90
Luminous Flux 2680Lm
Input voltage 180-265VAC/50-60Hz



COB 3x15W

CRI Ra≥80 / Ra≥90
Luminous Flux 4020Lm
Input voltage 180-265VAC/50-60Hz



OPTIONS

Driver

KGP 科谷特 PHILIPS

- A.non-dimmable B.TRIAC
- C.1-10V D.DALI

COB

CITIZEN 三洋 CREE VS LIGHTING SOLUTIONS

- 3000K 4000K 5000K

Finish

Standard WH

Optional BK

COB Beam angle



PHOTOMETRIC

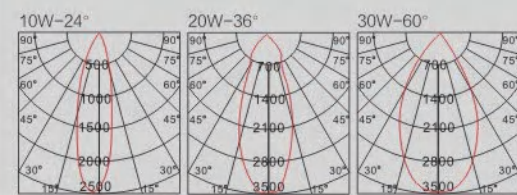

WL18A10A



WL18A20B



WL18A30C



WL18A40C

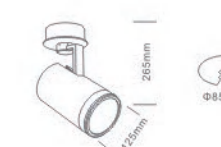
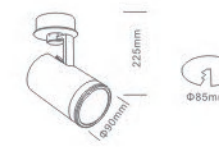

COB 10W

CRI Ra≥80 / Ra≥90
Luminous Flux 820Lm
Input voltage 180-265VAC/50-60Hz

COB 20W

CRI Ra≥80 / Ra≥90
Luminous Flux 1880Lm
Input voltage 180-265VAC/50-60Hz

COB 30W

CRI Ra≥80 / Ra≥90
Luminous Flux 2730Lm
Input voltage 180-265VAC/50-60Hz

COB 40W

CRI Ra≥80 / Ra≥90
Luminous Flux 3650Lm
Input voltage 180-265VAC/50-60Hz



PATENTED PRODUCTS 201510179699.7



20° 40° 60°

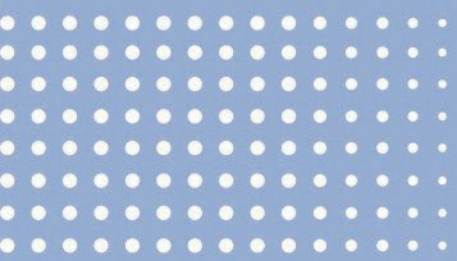

RONSE LIGHTING GRILLE LIGHT SERIES



RS-2106C-1 PAGE 129



RS-2106C-2 PAGE 129



RS-2106C-3 PAGE 129



RS-2115C PAGE 131



RS-2019A PAGE 133



RS-2019A-1 PAGE 135



RS-2019A-2 PAGE 137



RS-2019A-3 PAGE 139



WL19C10A PAGE 141



WL19C10A-1 PAGE 143



WL19C10A-2 PAGE 145



WL19C15B-3 PAGE 147



WL19B15B PAGE 149



WL19B15B-1 PAGE 151



WL19B15B-2 PAGE 151



WL19B15B-3 PAGE 151



TD18B12C PAGE 153



TD18B50C PAGE 155



OPTIONS

Driver

KGP 科谷特 TRIDONIC PHILIPS

- A.non-dimmable B.TRIAC
- C.1-10V D.DALI

COB

CITIZEN 晶元 CREE VS LIGHTING SOLUTIONS

- 3000K 4000K 5000K

Finish

Standard WH

Optional BK

COB Beam angle



PHOTOMETRIC

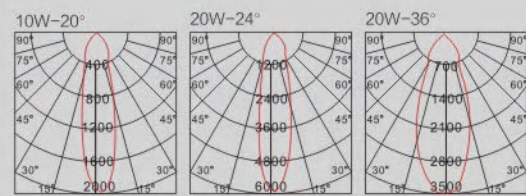

RS-2106C-1

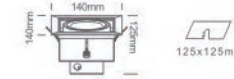

COB 10W

CRI Ra \geq 80 / Ra \geq 90
Luminous Flux 820Lm
Input voltage 180-265VAC/50-60Hz



RS-2106C-2

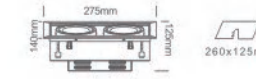

COB 2x10W

CRI Ra \geq 80 / Ra \geq 90
Luminous Flux 1640Lm
Input voltage 180-265VAC/50-60Hz



RS-2106C-3

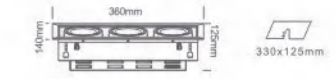

COB 3x10W

CRI Ra \geq 80 / Ra \geq 90
Luminous Flux 2460Lm
Input voltage 180-265VAC/50-60Hz



RS-2108C-1

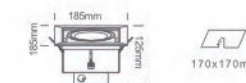

COB 20W

CRI Ra \geq 80 / Ra \geq 90
Luminous Flux 1820Lm
Input voltage 180-265VAC/50-60Hz



RS-2108C-2

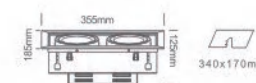

COB 2x20W

CRI Ra \geq 80 / Ra \geq 90
Luminous Flux 3640Lm
Input voltage 180-265VAC/50-60Hz



RS-2108C-3

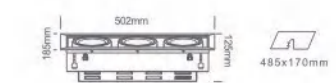

COB 3x20W

CRI Ra \geq 80 / Ra \geq 90
Luminous Flux 5460Lm
Input voltage 180-265VAC/50-60Hz



RS-2115C

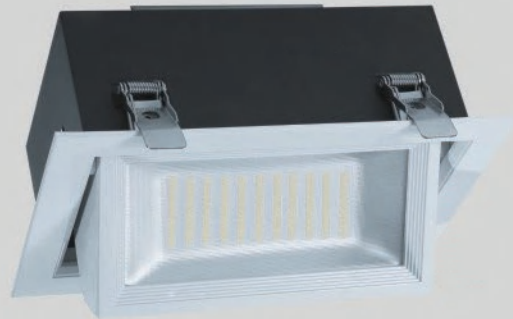

OPTIONS

Driver



A.non-dimmable

SMD



3000K 4000K 5000K

Finish

Standard WH

Optional BK

SMD Beam angle



SMD 45W

CRI Ra≥80
Luminous Flux 4050Lm
Input voltage 180-265VAC/50-60Hz

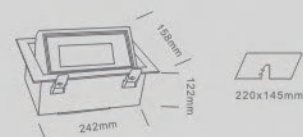

PHOTOMETRIC

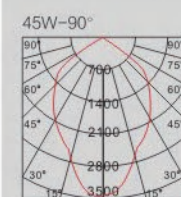



OPTIONS

Driver

KGP 科谷特 TRIDONIC PHILIPS

A.non-dimmable B.TRIAC
C.1-10V D.DALI

COB

CITIZEN 晶元 CREE VS LIGHTING SOLUTIONS

3000K 4000K 5000K

Finish

Standard WH

Optional BK

COB Beam angle



PHOTOMETRIC

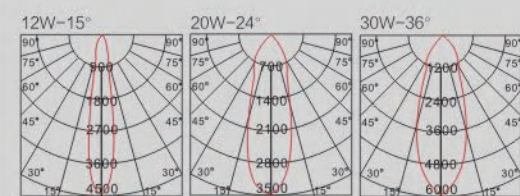

RS-2019A

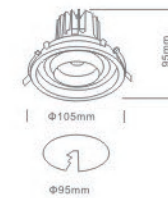
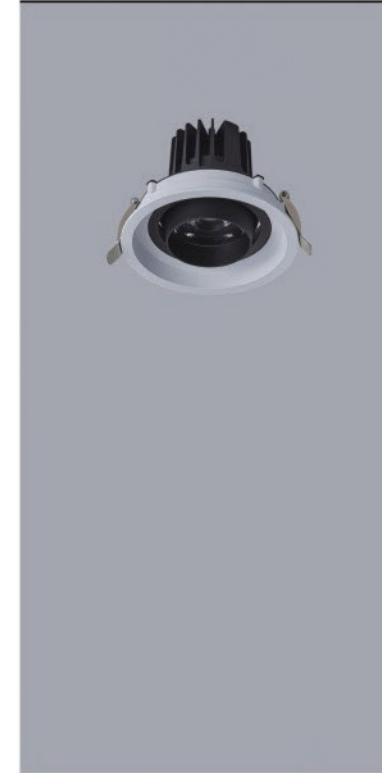

COB 12W

CRI Ra≥80 / Ra≥90
Luminous Flux 1010Lm
Input voltage 180-265VAC/50-60Hz



RS-2019B

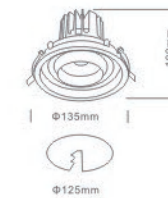

COB 20W

CRI Ra≥80 / Ra≥90
Luminous Flux 1840Lm
Input voltage 180-265VAC/50-60Hz



RS-2019C

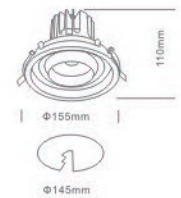

COB 30W

CRI Ra≥80 / Ra≥90
Luminous Flux 2720Lm
Input voltage 180-265VAC/50-60Hz





OPTIONS

Driver

KGP 科谷特 TRIDONIC PHILIPS

- A.non-dimmable B.TRIAC
- C.1-10V D.DALI

COB

CITIZEN Citizen CREE VS LIGHTING SOLUTIONS

- 3000K 4000K 5000K

Finish

Standard **WH**

Optional **BK**

COB Beam angle

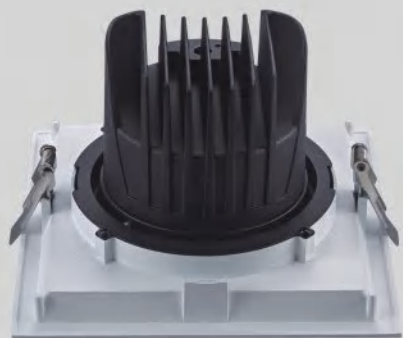

PHOTOMETRIC

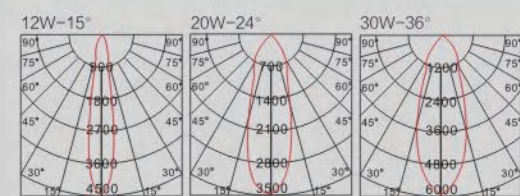

RS-2019A-1

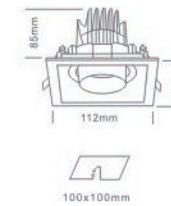

COB 12W

CRI Ra≥80 / Ra≥90
Luminous Flux 980Lm
Input voltage 180-265VAC/50-60Hz



RS-2019B-1

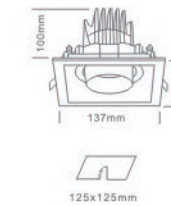
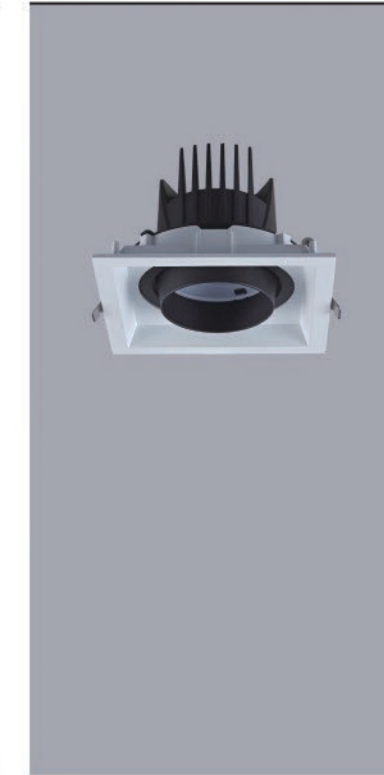

COB 20W

CRI Ra≥80 / Ra≥90
Luminous Flux 1890Lm
Input voltage 180-265VAC/50-60Hz



RS-2019C-1

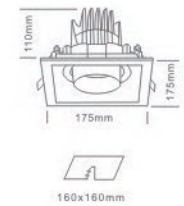

COB 30W

CRI Ra≥80 / Ra≥90
Luminous Flux 2710Lm
Input voltage 180-265VAC/50-60Hz



OPTIONS

Driver

KGP 科谷特 TRIDONIC PHILIPS

A.non-dimmable B.TRIAC
C.1-10V D.DALI

COB

CITIZEN 邦奇 LED 邦奇 LED CREE VS LIGHTING SOLUTIONS

3000K 4000K 5000K

Finish

Standard WH

Optional BK

COB Beam angle

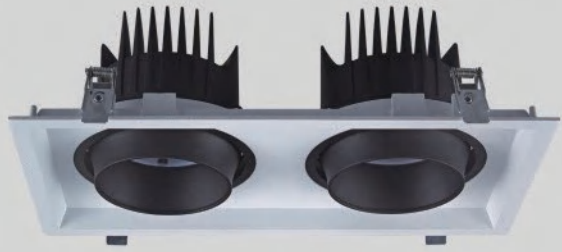

PHOTOMETRIC

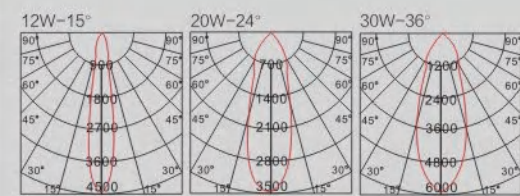

RS-2019A-2

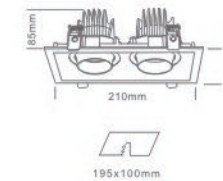

COB 2x12W

CRI Ra≥80 / Ra≥90
Luminous Flux 1940Lm
Input voltage 180-265VAC/50-60Hz



RS-2019B-2

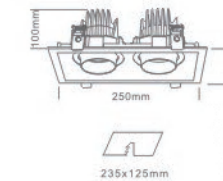

COB 2x20W

CRI Ra≥80 / Ra≥90
Luminous Flux 3720Lm
Input voltage 180-265VAC/50-60Hz



RS-2019C-2

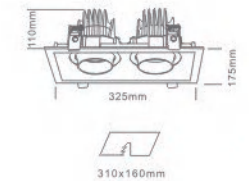
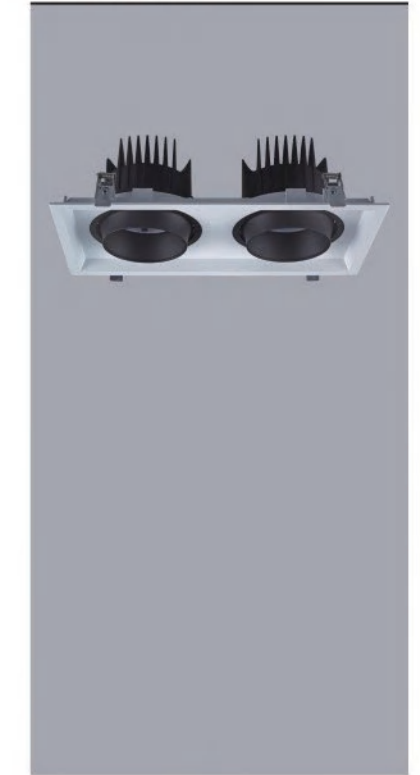

COB 2x30W

CRI Ra≥80 / Ra≥90
Luminous Flux 5420Lm
Input voltage 180-265VAC/50-60Hz



OPTIONS

Driver

KGP 科谷特 TRIDONIC PHILIPS

- A.non-dimmable B.TRIAC
- C.1-10V D.DALI

COB

CITIZEN 西竹光電 BORGLEIGHT 博格萊特 CREE VS LIGHTING SOLUTIONS

- 3000K 4000K 5000K

Finish

Standard WH

Optional BK

COB Beam angle

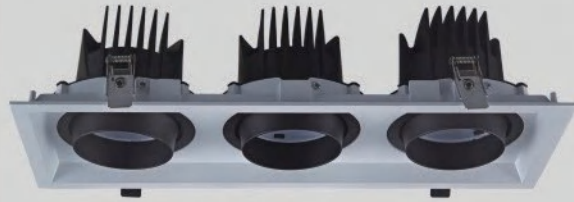

PHOTOMETRIC

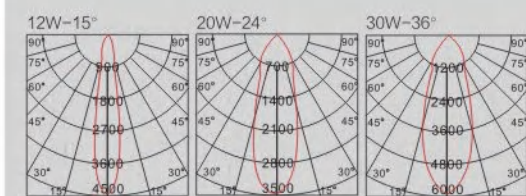

RS-2019A-3

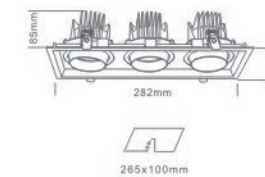
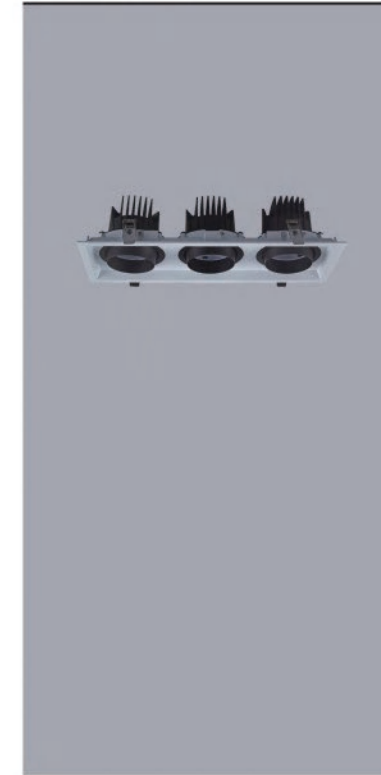

COB 3x12W

CRI Ra≥80 / Ra≥90
Luminous Flux 2910Lm
Input voltage 180-265VAC/50-60Hz



RS-2019B-3

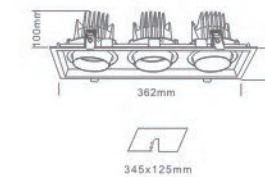
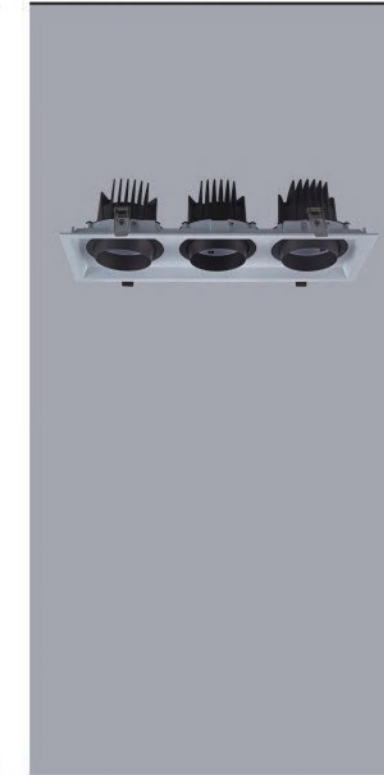

COB 3x20W

CRI Ra≥80 / Ra≥90
Luminous Flux 5580Lm
Input voltage 180-265VAC/50-60Hz



RS-2019C-3

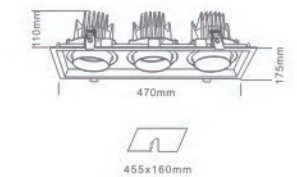
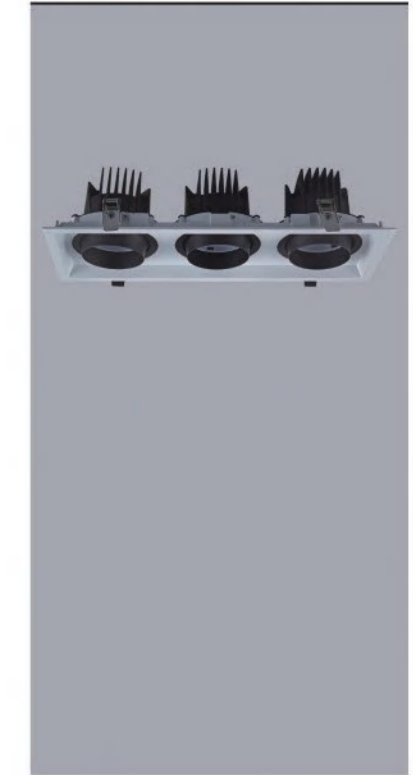

COB 3x30W

CRI Ra≥80 / Ra≥90
Luminous Flux 8120Lm
Input voltage 180-265VAC/50-60Hz





OPTIONS

Driver

KGP 科谷特 TRIDONIC PHILIPS

A.non-dimmable B.TRIAC
C.1-10V D.DALI

COB

CITIZEN 西村照工 CREE VS LIGHTING SOLUTIONS

3000K 4000K 5000K

Finish

Standard WH

Optional BK

COB Beam angle



PHOTOMETRIC

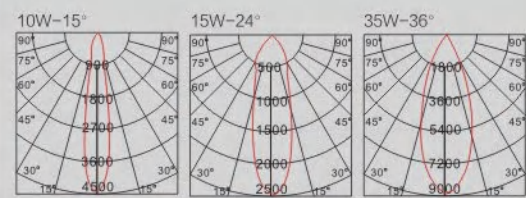

WL19C10A

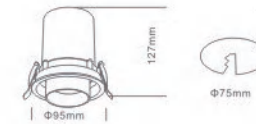

COB 10W

CRI Ra \geq 80 / Ra \geq 90
Luminous Flux 790Lm
Input voltage 180-265VAC/50-60Hz



WL19C15B

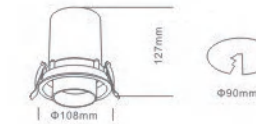

COB 15W

CRI Ra \geq 80 / Ra \geq 90
Luminous Flux 1380Lm
Input voltage 180-265VAC/50-60Hz



WL19C25C

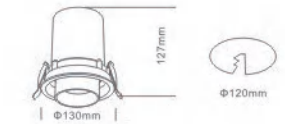

COB 25W

CRI Ra \geq 80 / Ra \geq 90
Luminous Flux 2280Lm
Input voltage 180-265VAC/50-60Hz



WL19C25E

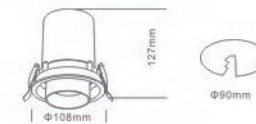

COB 25W

CRI Ra \geq 80 / Ra \geq 90
Luminous Flux 2190Lm
Input voltage 180-265VAC/50-60Hz

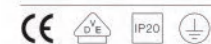

WL19C35D

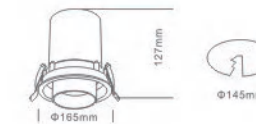

COB 35W

CRI Ra \geq 80 / Ra \geq 90
Luminous Flux 3180Lm
Input voltage 180-265VAC/50-60Hz





OPTIONS

Driver		
KGP 科谷特 TRIDONIC PHILIPS		
A.non-dimmable	B.TRIAC	
C.1-10V	D.DALI	
COB		
CITIZEN 西竹光電 BORGLE 邦格 CREE VS LIGHTING SOLUTIONS		
3000K	4000K 5000K	
Finish		
Standard	WH	
Optional	BK	
COB Beam angle		
15°	24°	36°

PHOTOMETRIC

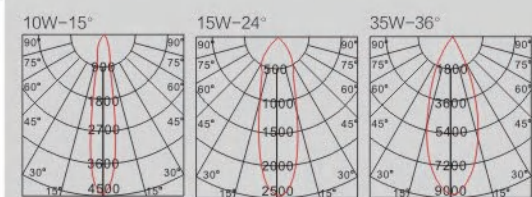

WL19C10A-1

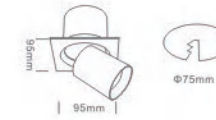

COB 10W	CRI	Ra≥80 / Ra≥90
	Luminous Flux	820Lm
	Input voltage	180-265VAC/50-60Hz



WL19C15B-1

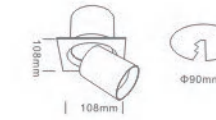

COB 15W	CRI	Ra≥80 / Ra≥90
	Luminous Flux	1340Lm
	Input voltage	180-265VAC/50-60Hz



WL19C25C-1

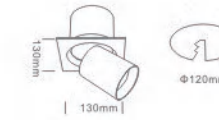

COB 25W	CRI	Ra≥80 / Ra≥90
	Luminous Flux	2320Lm
	Input voltage	180-265VAC/50-60Hz



WL19C25E-1

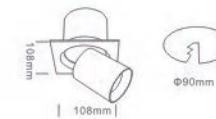

COB 25W	CRI	Ra≥80 / Ra≥90
	Luminous Flux	2230Lm
	Input voltage	180-265VAC/50-60Hz



WL19C35D-1

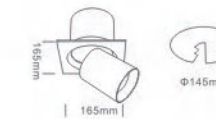

COB 35W	CRI	Ra≥80 / Ra≥90
	Luminous Flux	3210Lm
	Input voltage	180-265VAC/50-60Hz



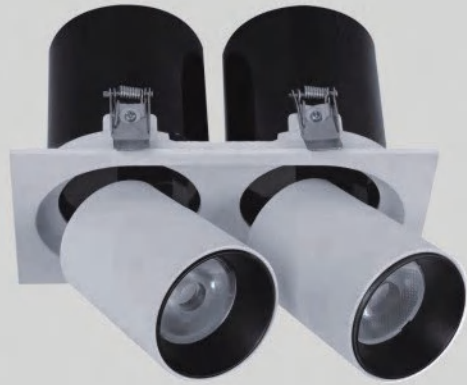

OPTIONS

Driver

KGP 科谷特 TRIDONIC PHILIPS

- A.non-dimmable B.TRIAC
- C.1-10V D.DALI

COB

CITIZEN 西村照光 CREE VS LIGHTING SOLUTIONS

- 3000K ● 4000K ● 5000K

Finish

Standard **WH**

Optional **BK**

COB Beam angle



PHOTOMETRIC

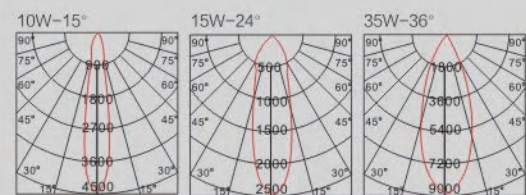

WL19C10A-2

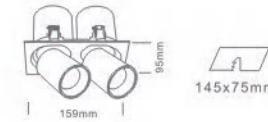

COB 10W

CRI Ra≥80 / Ra≥90
Luminous Flux 2x770Lm
Input voltage 180-265VAC/50-60Hz



WL19C15B-2

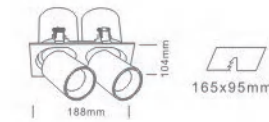

COB 15W

CRI Ra≥80 / Ra≥90
Luminous Flux 2x1350Lm
Input voltage 180-265VAC/50-60Hz



WL19C25C-2

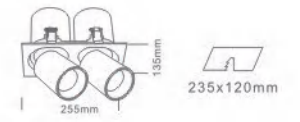

COB 25W

CRI Ra≥80 / Ra≥90
Luminous Flux 2x2310Lm
Input voltage 180-265VAC/50-60Hz



WL19C25E-2

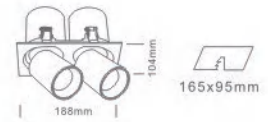

COB 25W

CRI Ra≥80 / Ra≥90
Luminous Flux 2x2150Lm
Input voltage 180-265VAC/50-60Hz



WL19C35D-2

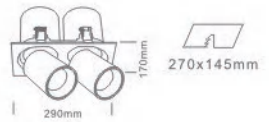

COB 35W

CRI Ra≥80 / Ra≥90
Luminous Flux 2x3160Lm
Input voltage 180-265VAC/50-60Hz





OPTIONS

Driver

KGP 科谷特 TRIDONIC PHILIPS

- A.non-dimmable B.TRIAC
- C.1-10V D.DALI

COB

CITIZEN 赛晶电子 CREE VS LIGHTING SOLUTIONS

- 3000K ● 4000K ● 5000K

Finish

Standard **WH**

Optional **BK**

COB Beam angle



PHOTOMETRIC

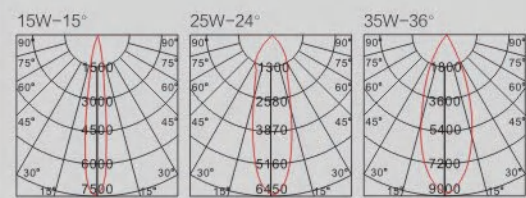

WL19C15B-3

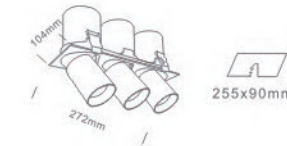

COB 15W

CRI Ra≥80 / Ra≥90
Luminous Flux 3x1410Lm
Input voltage 180-265VAC/50-60Hz



WL19C25C-3

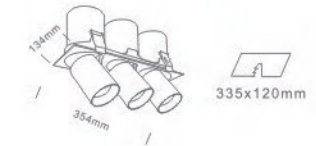

COB 25W

CRI Ra≥80 / Ra≥90
Luminous Flux 3x2310Lm
Input voltage 180-265VAC/50-60Hz



WL19C25E-3

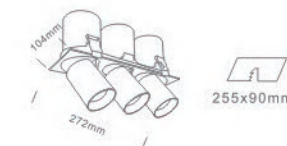

COB 25W

CRI Ra≥80 / Ra≥90
Luminous Flux 3x2180Lm
Input voltage 180-265VAC/50-60Hz



WL19C35D-3

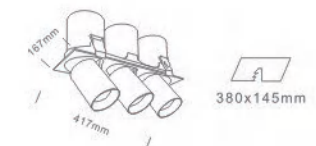

COB 35W

CRI Ra≥80 / Ra≥90
Luminous Flux 3x3360Lm
Input voltage 180-265VAC/50-60Hz



WL19B15B



OPTIONS

Driver

KGP 科谷特 TRIDONIC PHILIPS

- A.non-dimmable B.TRIAC
- C.1-10V D.DALI

COB

CITIZEN 西村照文 CREE VS LIGHTING SOLUTIONS

- 3000K ● 4000K ● 5000K

Finish

Standard WH

Optional BK

COB Beam angle



COB 15W

CRI Ra ≥ 80 / Ra ≥ 90
 Luminous Flux 1350Lm
 Input voltage 180-265VAC/50-60Hz

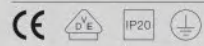

PHOTOMETRIC

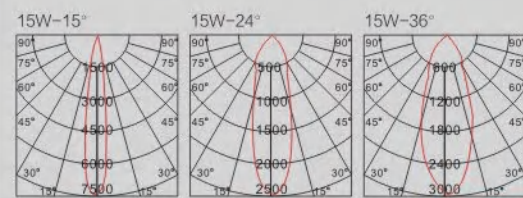

OPTIONS

Driver
KGP 科谷特 TRIDONIC **PHILIPS**
 A.non-dimmable B.TRIAC
 C.1-10V D.DALI

COB
 CITIZEN 邦奇 CREE VS LIGHTING SOLUTIONS
 3000K 4000K 5000K

Finish
 Standard WH
 Optional BK

COB Beam angle



PHOTOMETRIC

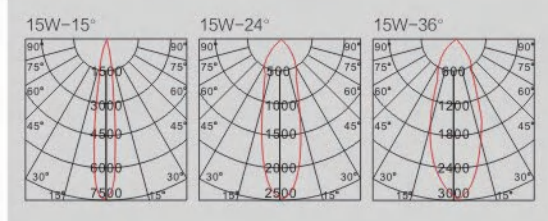

WL19B15B-1



WL19B15B-2

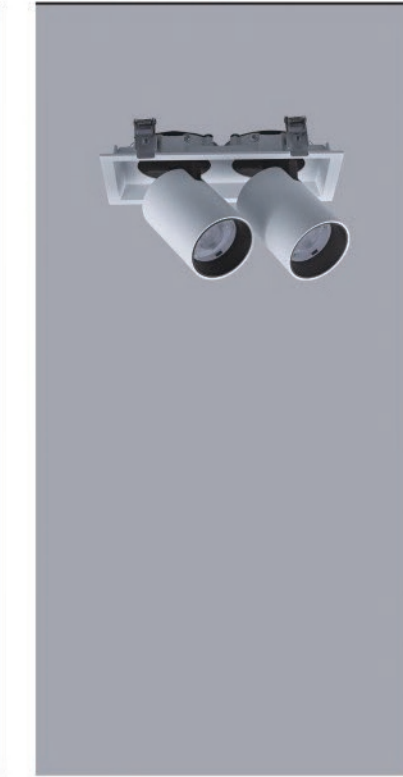

WL19B15B-3

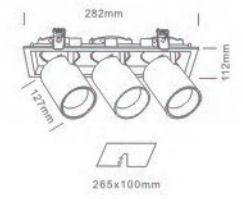
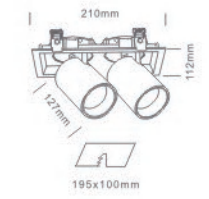
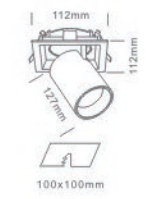
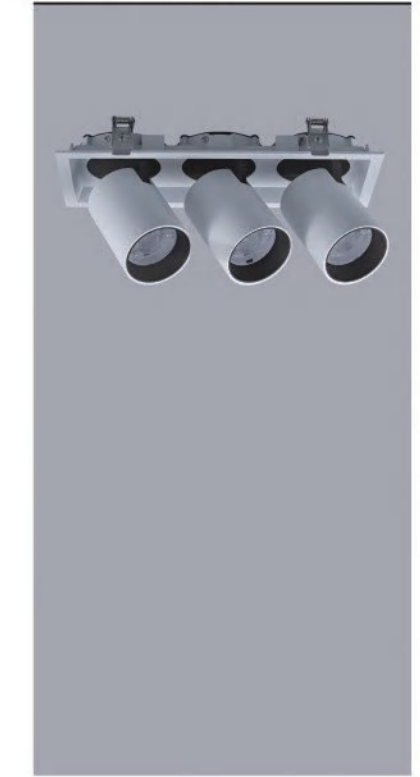

COB 15W
 CRI Ra≥80 / Ra≥90
 Luminous Flux 1390Lm
 Input voltage 180-265VAC/50-60Hz

COB 2x15W
 CRI Ra≥80 / Ra≥90
 Luminous Flux 2780Lm
 Input voltage 180-265VAC/50-60Hz

COB 3x15W
 CRI Ra≥80 / Ra≥90
 Luminous Flux 4170Lm
 Input voltage 180-265VAC/50-60Hz



OPTIONS

Driver

KGP 科谷特 TRIDONIC PHILIPS

A.non-dimmable B.TRIAC

C.1-10V D.DALI

SMD

BRIDGELUX 晶元光电 CREE

3000K 4000K 5000K

Finish

Standard WH

Optional BK

SMD Beam angle

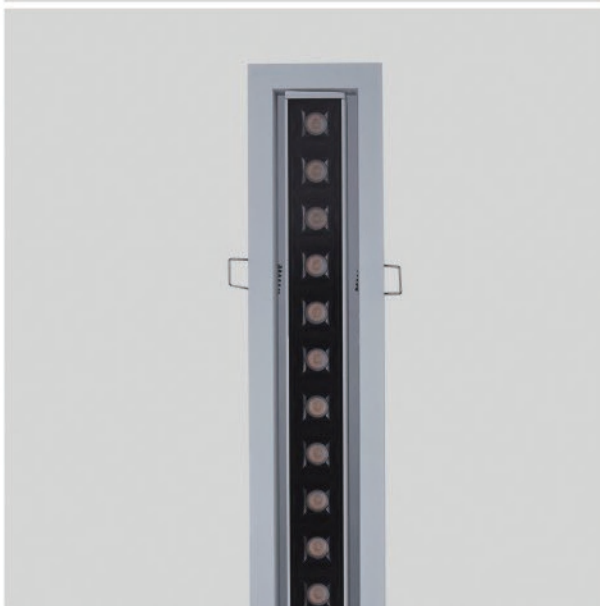

TD18B12C

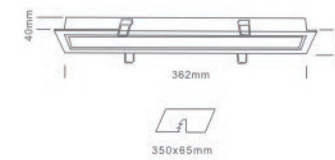

SMD 12W

CRI Ra \geq 80 / Ra \geq 90
Luminous Flux 910Lm
Input voltage 180-265VAC/50-60Hz



TD18B24C

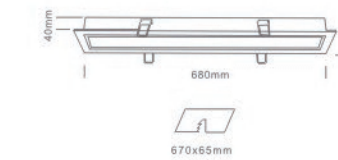
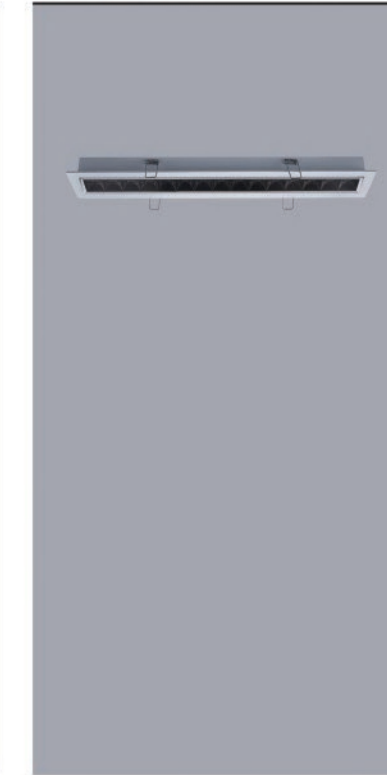

SMD 24W

CRI Ra \geq 80 / Ra \geq 90
Luminous Flux 1820Lm
Input voltage 180-265VAC/50-60Hz



TD18B36C

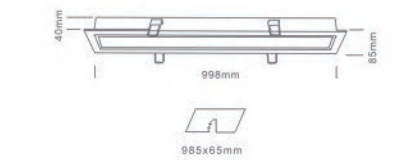

SMD 36W

CRI Ra \geq 80 / Ra \geq 90
Luminous Flux 2710Lm
Input voltage 180-265VAC/50-60Hz



TD18B50C



OPTIONS

Driver

KGP 科谷特 TRIDONIC PHILIPS

A.non-dimmable B.TRIAC

C.1-10V D.DALI

SMD



3000K 4000K 5000K

Finish

Standard WH

Optional BK

SMD Beam angle



SMD 50W

CRI Ra≥80 / Ra≥90
Luminous Flux 3750Lm
Input voltage 180-265VAC/50-60Hz





RONSE LIGHTING
SURFACE MOUNTED
DOWNLIGHT SERIES



RS-2605A PAGE 159



RS-2606A PAGE 161



OPTIONS

Driver

KGP 科谷 科谷 PHILIPS

- A.non-dimmable B.TRIAC
- C.1-10V D.DALI

COB

CITIZEN 科锐 CREE VS LIGHTING SOLUTIONS

- 3000K 4000K 5000K

Finish

Standard WH

Optional BK

COB Beam angle



PHOTOMETRIC

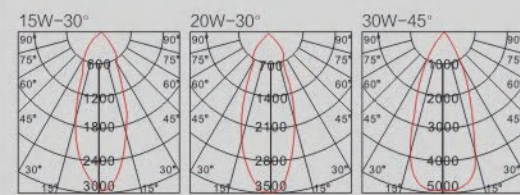

RS-2605A



RS-2605B



RS-2605C



COB 15W

CRI Ra \geq 80 / Ra \geq 90
 Luminous Flux 1370Lm
 Input voltage 180-265VAC/50-60Hz



COB 20W

CRI Ra \geq 80 / Ra \geq 90
 Luminous Flux 1830Lm
 Input voltage 180-265VAC/50-60Hz



COB 30W

CRI Ra \geq 80 / Ra \geq 90
 Luminous Flux 2780Lm
 Input voltage 180-265VAC/50-60Hz





OPTIONS

Driver

KGP 科基特 PHILIPS

- A.non-dimmable B.TRIAC
- C.1-10V D.DALI

COB

CITIZEN 西村精工 CREE VS LIGHTING SOLUTIONS

- 3000K 4000K 5000K

Finish

Standard WH

Optional BK

COB Beam angle



Accessory



PHOTOMETRIC

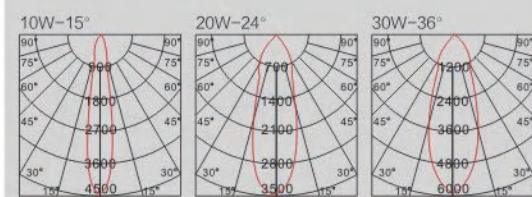

RS-2606A



RS-2606B



RS-2606C



COB 10W

CRI	Ra≥80 / Ra≥90
Luminous Flux	840Lm
Input voltage	180-265VAC/50-60Hz



COB 20W

CRI	Ra≥80 / Ra≥90
Luminous Flux	1870Lm
Input voltage	180-265VAC/50-60Hz



COB 30W

CRI	Ra≥80 / Ra≥90
Luminous Flux	2730Lm
Input voltage	180-265VAC/50-60Hz





RONSE LIGHTING HANGING LIGHT SERIES



RS-2330C PAGE 165

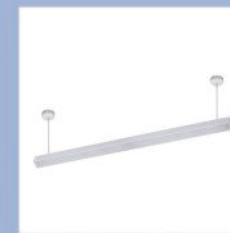

RS-2340D PAGE 167



RS-2350 PAGE 169

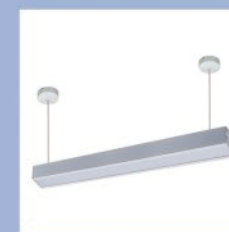

RS-2340 PAGE 170



RS-2305A PAGE 171



RS-2306A PAGE 173



RS-2318 PAGE 175

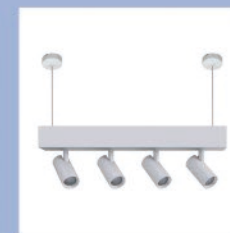

RS2310K-4 PAGE 177



RS2610K-4 PAGE 179

OPTIONS

Driver

Driver on board
A.non-dimmable

SMD



3000K 4000K 5000K

Finish

Standard WH

Optional BK

SMD Beam angle



Accessory



White

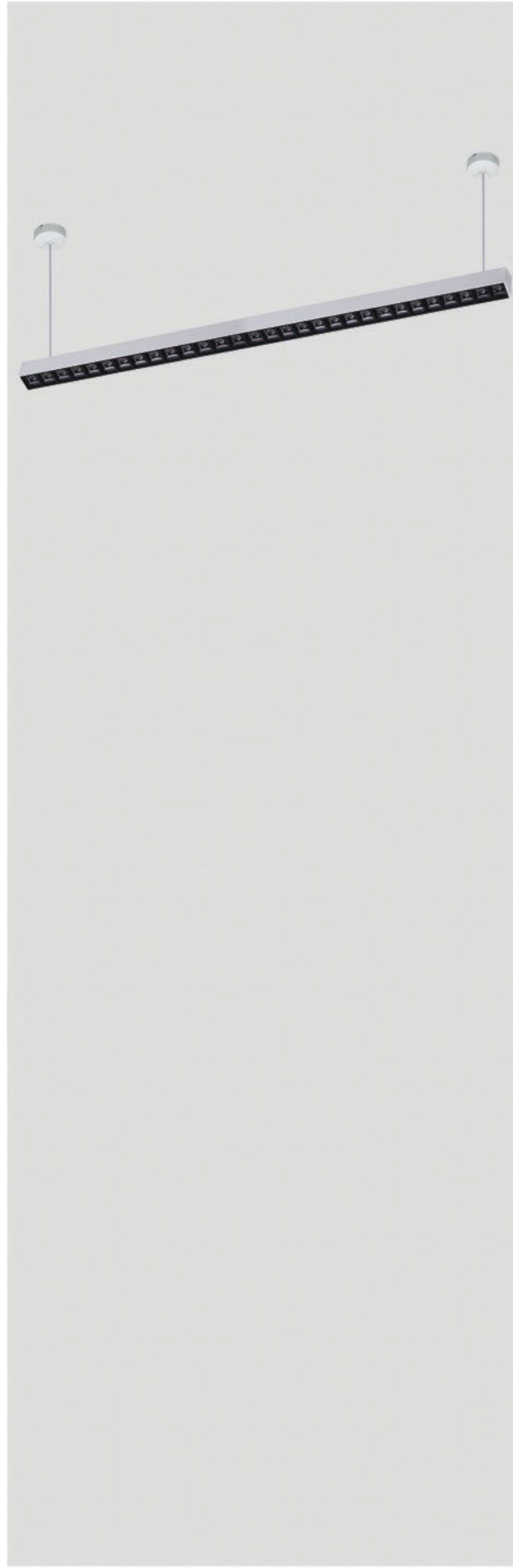

RS-2330C

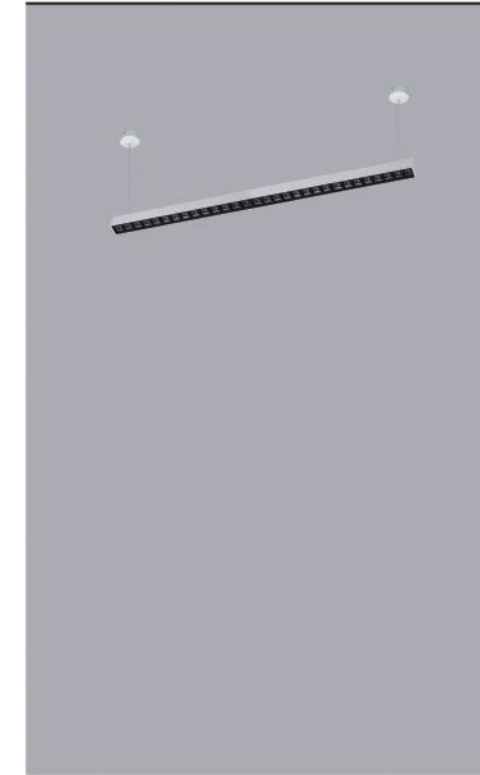

RS-2345C

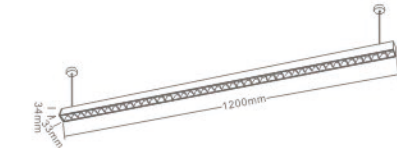
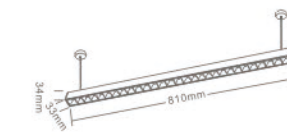
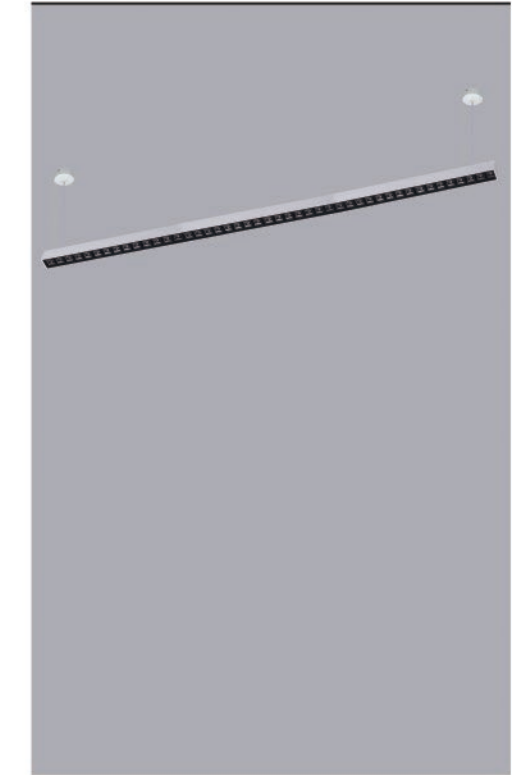

SMD 30W

CRI Ra \geq 80 / Ra \geq 90
Luminous Flux 2250Lm
Input voltage 180-265VAC/50-60Hz



SMD 45W

CRI Ra \geq 80 / Ra \geq 90
Luminous Flux 3375Lm
Input voltage 180-265VAC/50-60Hz



OPTIONS

Driver

Driver on board
A.non-dimmable

SMD



3000K 4000K 5000K

Finish

Standard WH

Optional BK

SMD Beam angle



RS-2340D

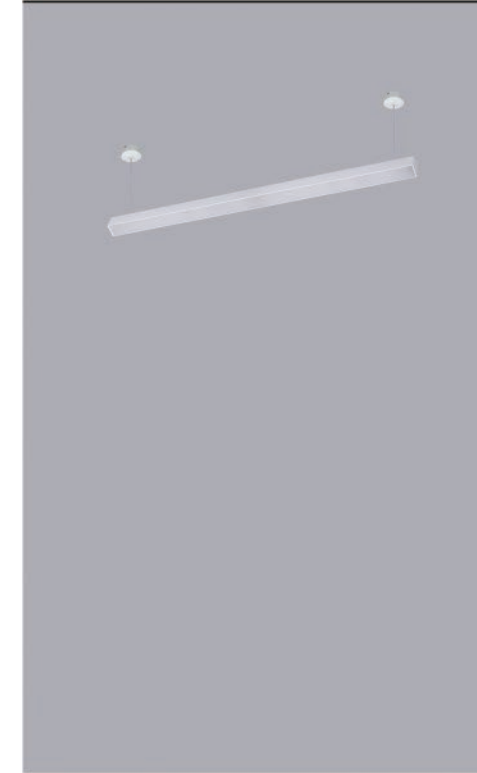

RS-2360D

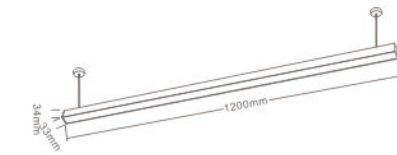
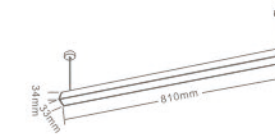
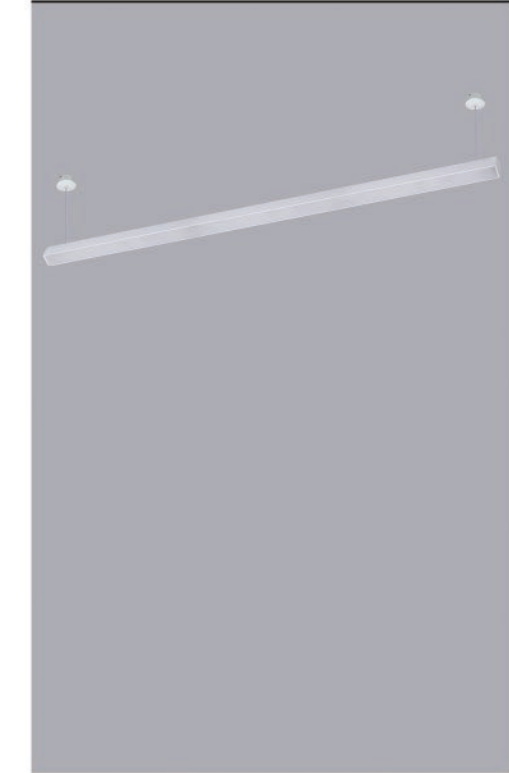

SMD 40W

CRI Ra ≥ 80 / Ra ≥ 90
Luminous Flux 2840Lm
Input voltage 180-265VAC/50-60Hz



SMD 60W

CRI Ra ≥ 80 / Ra ≥ 90
Luminous Flux 4260Lm
Input voltage 180-265VAC/50-60Hz



RS-2350



OPTIONS

Driver

KGP 科谷光源 LiFud
 A.non-dimmable B.TRIAC
 C.1-10V D.DALI

SMD

BRIDGELUX 晶一光电 CREE
 3000K 4000K 5000K

Finish

Standard WH

Optional BK

SMD Beam angle



Accessory



SMD 100W

CRI Ra≥80 / Ra≥90
 Luminous Flux 7510Lm
 Input voltage 180-265VAC/50-60Hz

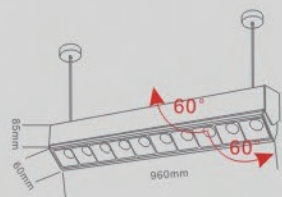
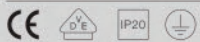

RS-2340



OPTIONS

Driver

KGP 科谷光源 LiFud
 A.non-dimmable B.TRIAC
 C.1-10V D.DALI

SMD

AMTC 晶一光电 BRIDGELUX
 3000K 4000K 5000K

Finish

Standard WH

Optional BK

SMD Beam angle



SMD 80W

CRI Ra≥80 / Ra≥90
 Luminous Flux 7210Lm
 Input voltage 180-265VAC/50-60Hz

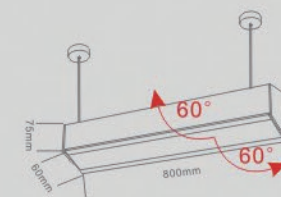

OPTIONS

Driver

KGP 科谷特 PHILIPS

- A.non-dimmable B.TRIAC
- C.1-10V D.DALI

COB

CITIZEN 邦奇 CREE VS LIGHTING SOLUTIONS

- 3000K ● 4000K ● 5000K

Finish

Standard WH

Optional BK

COB Beam angle



RS-2305A



RS-2305B

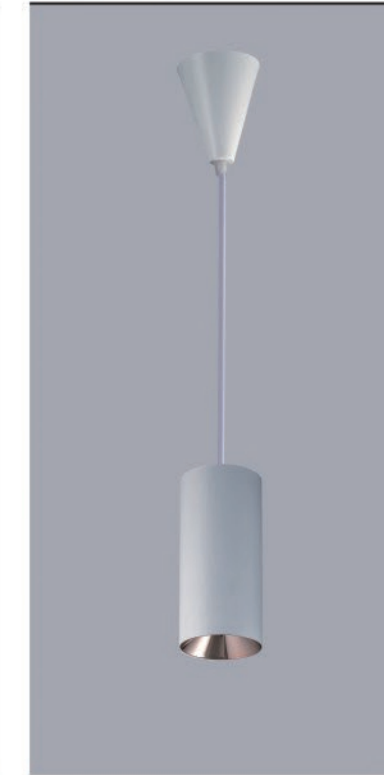

RS-2305C



COB 15W

CRI Ra≥80 / Ra≥90
Luminous Flux 1370Lm
Input voltage 180-265VAC/50-60Hz

COB 20W

CRI Ra≥80 / Ra≥90
Luminous Flux 1780Lm
Input voltage 180-265VAC/50-60Hz

COB 30W

CRI Ra≥80 / Ra≥90
Luminous Flux 2750Lm
Input voltage 180-265VAC/50-60Hz



PHOTOMETRIC

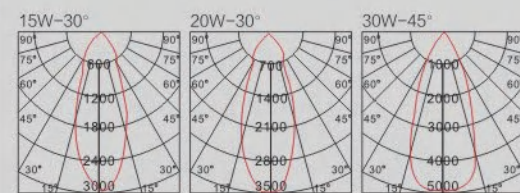

OPTIONS

Driver

KGP 科谷特 PHILIPS

A.non-dimmable B.TRIAC
C.1-10V D.DALI

COB

CITIZEN 邦奇 CREE VS LIGHTING SOLUTIONS

3000K 4000K 5000K

Finish

Standard WH

Optional BK

COB Beam angle



Accessory



PHOTOMETRIC

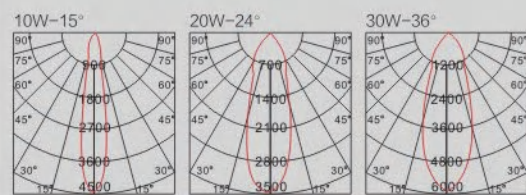

RS-2306A



RS-2306B



RS-2306C



COB 10W

CRI Ra \geq 80 / Ra \geq 90
Luminous Flux 840Lm
Input voltage 180-265VAC/50-60Hz



COB 20W

CRI Ra \geq 80 / Ra \geq 90
Luminous Flux 1790Lm
Input voltage 180-265VAC/50-60Hz



COB 30W

CRI Ra \geq 80 / Ra \geq 90
Luminous Flux 2710Lm
Input voltage 180-265VAC/50-60Hz





OPTIONS

Driver

KGP 科谷特 PHILIPS

- A.non-dimmable B.TRIAC
- C.1-10V D.DALI

COB

CITIZEN 晶元 CREE VS LIGHTING SOLUTIONS

- 3000K ● 4000K ● 5000K

Finish

Standard WH

Optional BK

COB Beam angle



PHOTOMETRIC

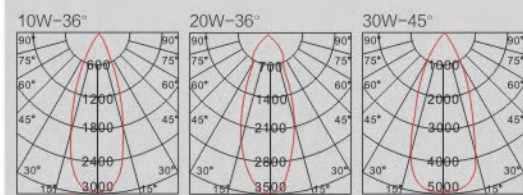

RS-2318



RS-2319



RS-2320

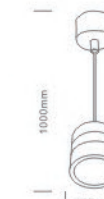

COB 10W

CRI Ra≥80 / Ra≥90
Luminous Flux 840Lm
Input voltage 180-265VAC/50-60Hz



COB 20W

CRI Ra≥80 / Ra≥90
Luminous Flux 1820Lm
Input voltage 180-265VAC/50-60Hz



COB 30W

CRI Ra≥80 / Ra≥90
Luminous Flux 2780Lm
Input voltage 180-265VAC/50-60Hz



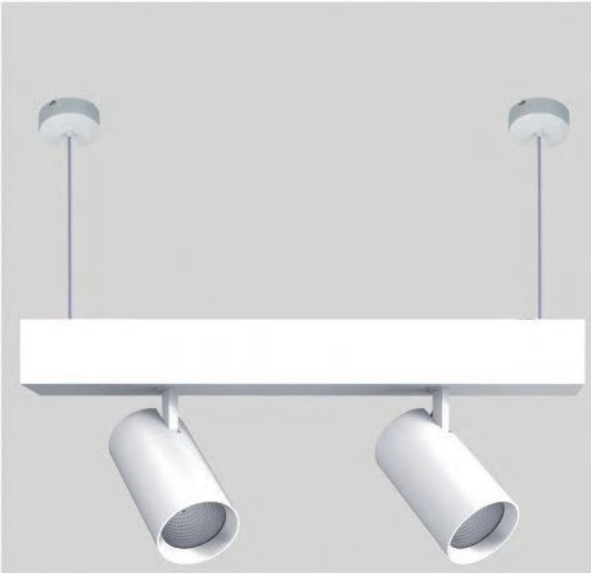

OPTIONS

Driver
 KGP 科谷特 TRIDONIC PHILIPS
 A.non-dimmable B.TRIAC
 C.1-10V D.DALI

COB
 CITIZEN 西竹光電 CREE Cree VS LIGHTING SOLUTIONS
 3000K 4000K 5000K

Finish
 Standard WH
 Optional BK

COB Beam angle
 15° 23° 38° 45° 60°

PHOTOMETRIC

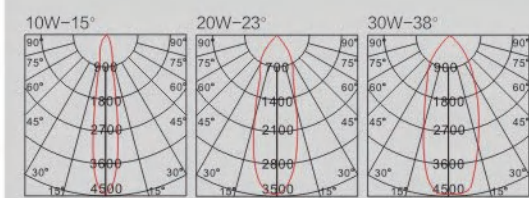

RS2310K-4

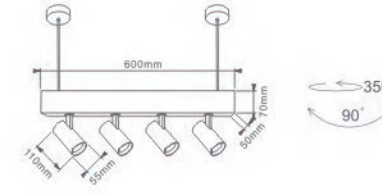
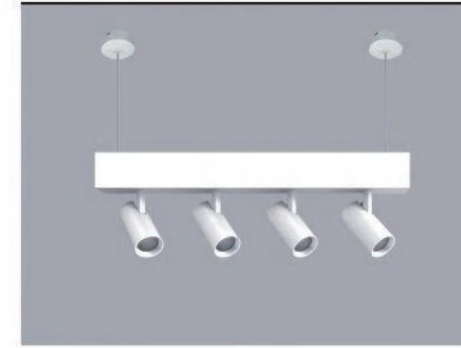

COB 4x10W
 CRI Ra≥80 / Ra≥90
 Luminous Flux 4x810Lm
 Input voltage 180-265VAC/50-60Hz



RS2320K-4

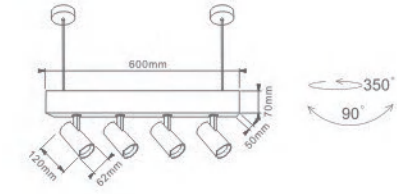

COB 4x20W
 CRI Ra≥80 / Ra≥90
 Luminous Flux 4x1610Lm
 Input voltage 180-265VAC/50-60Hz



RS2330K-3

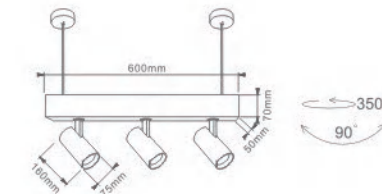
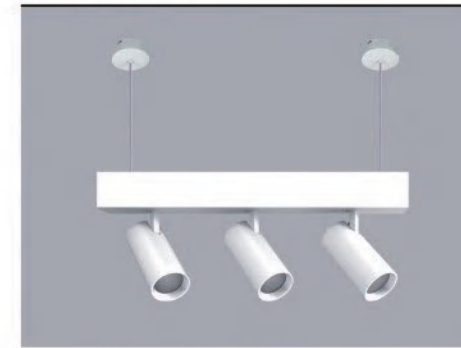

COB 3x30W
 CRI Ra≥80 / Ra≥90
 Luminous Flux 3x2430Lm
 Input voltage 180-265VAC/50-60Hz



RS2340K-2

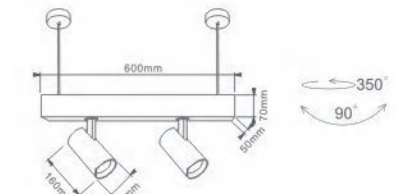
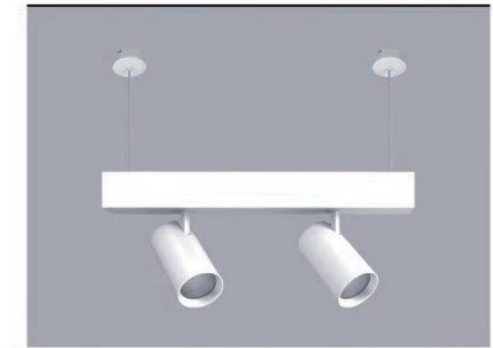

COB 2x40W
 CRI Ra≥80 / Ra≥90
 Luminous Flux 2x3210Lm
 Input voltage 180-265VAC/50-60Hz



OPTIONS

Driver

KGP 科谷特 TRIDONIC PHILIPS

A.non-dimmable B.TRIAC
C.1-10V D.DALI

COB

CITIZEN 村田 CREE VS LIGHTING SOLUTIONS

3000K 4000K 5000K

Finish

Standard WH

Optional BK

COB Beam angle



PHOTOMETRIC

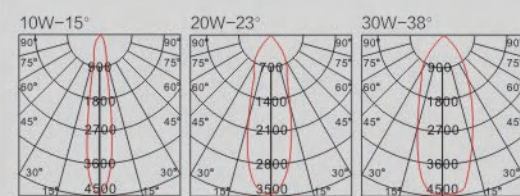

RS2610K-4

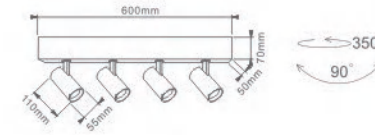
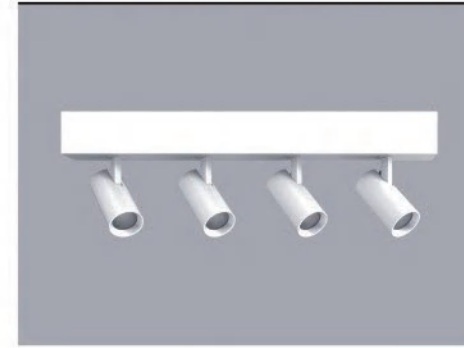

COB 4x10W

CRI Ra \geq 80 / Ra \geq 90
Luminous Flux 4x810Lm
Input voltage 180-265VAC/50-60Hz



RS2620K-4

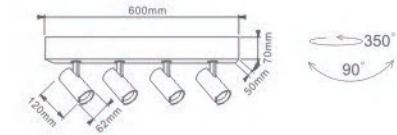
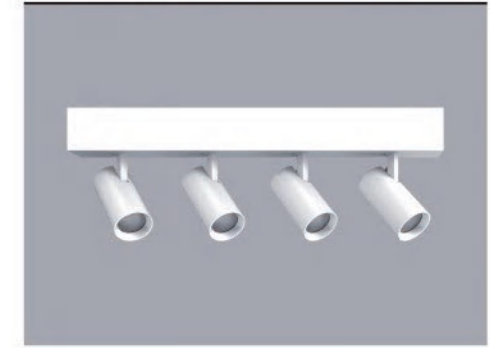

COB 4x20W

CRI Ra \geq 80 / Ra \geq 90
Luminous Flux 4x1610Lm
Input voltage 180-265VAC/50-60Hz



RS2630K-3

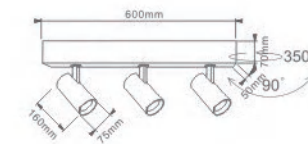
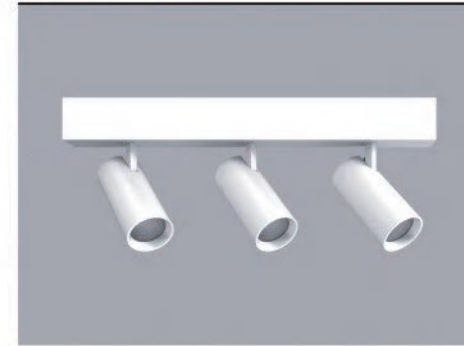

COB 3x30W

CRI Ra \geq 80 / Ra \geq 90
Luminous Flux 3x2430Lm
Input voltage 180-265VAC/50-60Hz



RS2640K-2

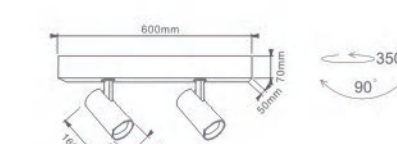
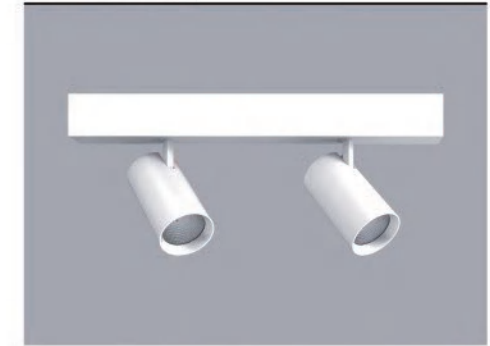

COB 2x40W

CRI Ra \geq 80 / Ra \geq 90
Luminous Flux 2x3210Lm
Input voltage 180-265VAC/50-60Hz





RONSE LIGHTING
FLOOD LIGHT
SERIES



FL02E030 PAGE 183





FL01D010 PAGE 185



FL01A010 PAGE 187

OPTIONS

Driver	DOB
SMD	 ● 3000K ● 4000K ● 6500K
Finish	Standard WH Optional BK
SMD Beam angle	 110°
Accessory	 Sensor

Bevel design
good for installation

COMPARING

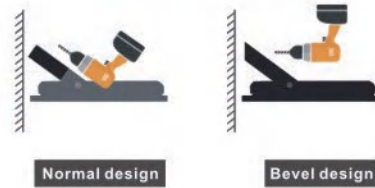

Normal design

Bevel design



FL02E030

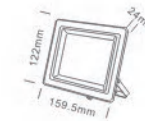
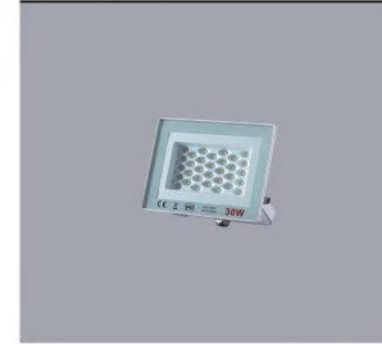

● SMD 30W

CRI	Ra≥80 / Ra≥90
Luminous Flux	1850Lm
Input voltage	220-265VAC/50-60Hz



FL02E050

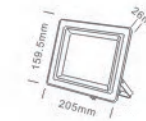

● SMD 50W

CRI	Ra≥80 / Ra≥90
Luminous Flux	3140Lm
Input voltage	220-265VAC/50-60Hz



FL02E100

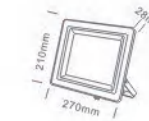
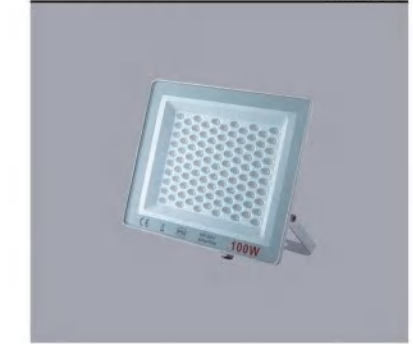

● SMD 100W

CRI	Ra≥80 / Ra≥90
Luminous Flux	6170Lm
Input voltage	220-265VAC/50-60Hz



FL02E150

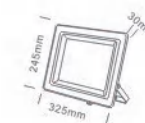

● SMD 150W

CRI	Ra≥80 / Ra≥90
Luminous Flux	9330Lm
Input voltage	220-265VAC/50-60Hz



FL02E200

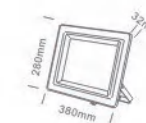

● SMD 200W

CRI	Ra≥80 / Ra≥90
Luminous Flux	18420Lm
Input voltage	220-265VAC/50-60Hz



FL02E300

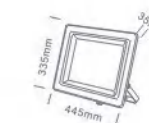

● SMD 300W

CRI	Ra≥80 / Ra≥90
Luminous Flux	18590Lm
Input voltage	220-265VAC/50-60Hz



OPTIONS

Driver

DOB

SMD



3000K 4000K 6500K RGB

Finish

Standard WH

Optional BK

SMD Beam angle



Accessory



Sensor



FL01D010



SMD 10W

CRI Ra \geq 80 / Ra \geq 90
Luminous Flux 610Lm
Input voltage 220-265VAC/50-60Hz



FL02D030



SMD 30W

CRI Ra \geq 80 / Ra \geq 90
Luminous Flux 1860Lm
Input voltage 220-265VAC/50-60Hz



FL03D050

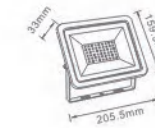

SMD 50W

CRI Ra \geq 80 / Ra \geq 90
Luminous Flux 3120Lm
Input voltage 220-265VAC/50-60Hz



FL04D100

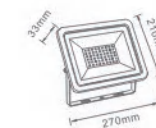
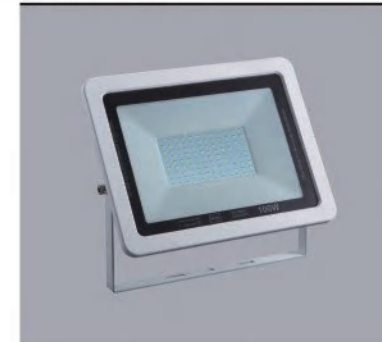

SMD 100W

CRI Ra \geq 80 / Ra \geq 90
Luminous Flux 6120Lm
Input voltage 220-265VAC/50-60Hz



FL05D200



SMD 200W

CRI Ra \geq 80 / Ra \geq 90
Luminous Flux 12550Lm
Input voltage 220-265VAC/50-60Hz



FL06D300

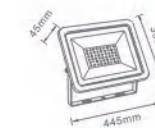

SMD 300W

CRI Ra \geq 80 / Ra \geq 90
Luminous Flux 18590Lm
Input voltage 220-265VAC/50-60Hz



OPTIONS

Driver
DOB

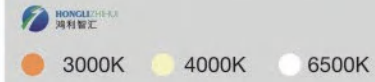
SMD

 3000K 4000K 6500K

Finish
Standard WH

Optional BK

SMD Beam angle



Accessory



FL01A010

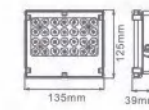

SMD 10W

CRI Ra \geq 80 / Ra \geq 90
Luminous Flux 620Lm
Input voltage 220-265VAC/50-60Hz



FL02A020

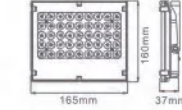
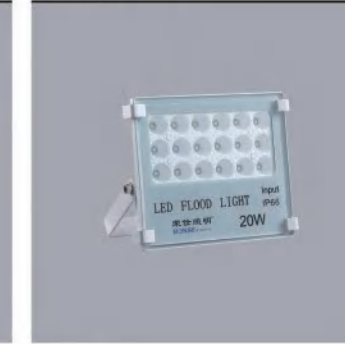

SMD 20W

CRI Ra \geq 80 / Ra \geq 90
Luminous Flux 1260Lm
Input voltage 220-265VAC/50-60Hz



FL03B030

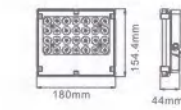

SMD 30W

CRI Ra \geq 80 / Ra \geq 90
Luminous Flux 1860Lm
Input voltage 220-265VAC/50-60Hz

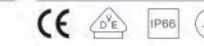

FL04B050

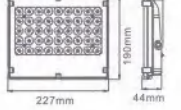

SMD 50W

CRI Ra \geq 80 / Ra \geq 90
Luminous Flux 3050Lm
Input voltage 220-265VAC/50-60Hz

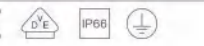

FL05B100

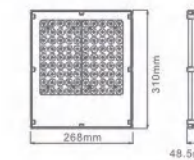

SMD 100W

CRI Ra \geq 80 / Ra \geq 90
Luminous Flux 6130Lm
Input voltage 220-265VAC/50-60Hz



FL06B150

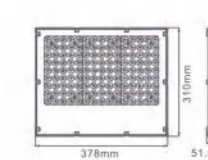
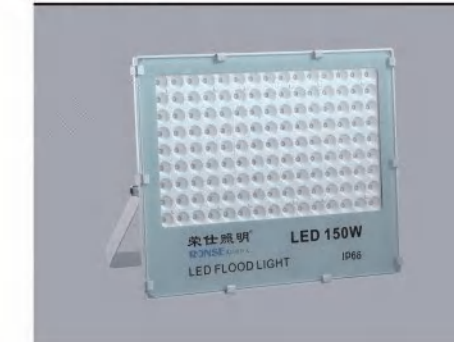

SMD 150W

CRI Ra \geq 80 / Ra \geq 90
Luminous Flux 9340Lm
Input voltage 220-265VAC/50-60Hz



FL07B200

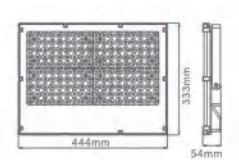
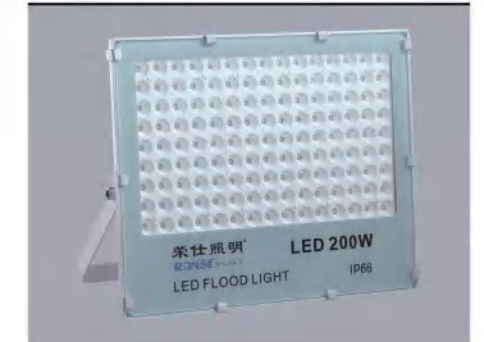

SMD 200W

CRI Ra \geq 80 / Ra \geq 90
Luminous Flux 12460Lm
Input voltage 220-265VAC/50-60Hz

