

图片仅供参考，请以实物为准。本公司保留对产品外观及技术改进的权利，恕不另行通知。
Picture is only for reference only, please subject to our available product. We reserve the right to revise product technical parameter without notice.

荣仕照明®
RONSE our sunshine



佛山市荣仕照明科技有限公司 Foshan Ronse Lighting Technology Co.,Ltd.

地址: 中国广东省佛山市南海区丹灶镇金沙联沙工业区
Add: Liansha Industrial Zone, Jinsha, Danzao Town, Nanhai, Foshan, Guangdong, China.
电话(Tel): +86-757-86609111 86609916
传真(Fax): +86-757-86616106
Http: //www.ronse.cc
E-mail: info@ronse.cc; rs909@21cn.com



企业官网



微官网

2018 CATALOGUE
New

RONSE

COMPANY INTRODUCTION

佛山市荣仕照明科技有限公司是一家致力于LED应用照明产品研发、生产、销售及服务的专业型照明企业，座落于珠三角经济重镇广东省佛山市南海区丹灶镇，毗邻广州、香港等国际化前沿城市，交通极为便利；公司具有悠久的发展历史，在LED应用照明产品的开发和市场的开拓方面积累了丰富的经验，并于2015年被有关部门认定为国家级高新技术企业。

荣仕照明经过多年的发展，现已发展成为具有一定规模的专业照明企业，厂区占地面积超过30000多平方米，公司引进了具有国际先进水平的生产加工设备、数控自动加工设备，自动喷漆设备，以及专业的光电检测及老化设备，同时拥有专业的LED应用照明产品的研发、设计团队，生产管理团队以及销售团队，严格实行ISO9001:2000国际质量管理体系标准，产品先后通过了CE、RoHS、TUV、CCC等多项国际国内认证，并获得多项专利。

作为专业的LED应用照明产品制造商，“荣仕照明”多年一直致力开发出深受消费者喜爱的照明产品，产品主要包括：LED射灯、LED天花灯、LED筒灯、LED格栅灯、LED吊灯以及LED球泡灯等多个种类产品，涵盖LED大功率，LED贴片，COB等多个系列。

荣仕照明以“安全节能、绿色环保”为核心，秉承“热情诚信，科技创新”的经营理念，不断追求产品的美观性和实用性，凭借优质的产品和完善的售后服务，产品畅销海内外数十个国家和地区，赢得了广大客户的信赖和好评。

面向未来，我们持续探索，不断超越.....

Foshan Ronse Lighting Technology Co.,Ltd. is a National high-tech enterprises of R&D, Manufacturing, Marketing and Services in LED application lighting products, located in Danzao Town, Nanhai, Foshan, Guangdong-, as a professional manufacturer with a long history, our company has accumulated rich experience in research and development and marketing in this burgeoning led application lighting industry .

After many years' development, Ronse Lighting has developed to be one of professional manufacturers for led lighting products, and own Workshop Area more than 30,000 M2 , we adopt advanced processing equipments, automatic CNC processing equipments , automatic paint spraying apparatus and testing equipment; own professional and veteran team in R&D, , management and sales, we Strictly implement ISO9001:2000 international quality management system standard, all of our products have passed CE, RoHS, TUV, CCC certificate, and own several patents.

Main products of Ronse Lighting include: led spot light , led ceiling light , led down light , led grille light , led pendant light and led bulbs etc. are including Several series of products like high power LED, SMD ,COB etc.

“safe and energy-saving, Green and environment friendly” is our design concept, “Enthusiasm and Honest, Technological innovation” is our management philosophy , we always pursue more beautiful and practical products , With excellent quality and best after-sales service , our products have been sell very well in many countries , and Won trust and high praise from our customers.

Looking to the future, we will continue to explore, constantly beyond, with somebody like you from all over world.





厂区一角 WORKSHOP

拥有国际先进水平的研发、生产、检测设备。
专业的技术检验、检测，确保产品质量。
让每一个合作伙伴放心。
让每一个客户满意。

Dayton has the international advanced level of research and development, production and testing equipment. Professional technical inspection and testing to ensure product quality. Let our partner and customer be satisfy to our products and service

研究与开发 RESEARCH AND DEVELOPMENT

产品和技术创新作为企业创新的核心内容，孜孜不倦的追求；将产品研发与技术研发合为一体，同时兼顾客户的需求和市场的可行性，争取在商业上，产品创新上都取得成功。

Products and technological innovation is the core of the enterprise innovation, is the tireless pursuit; integrating product and technology development into a whole, meanwhile, both the requirements of customers and the market feasibility are considered to obtain success in business and product innovation.

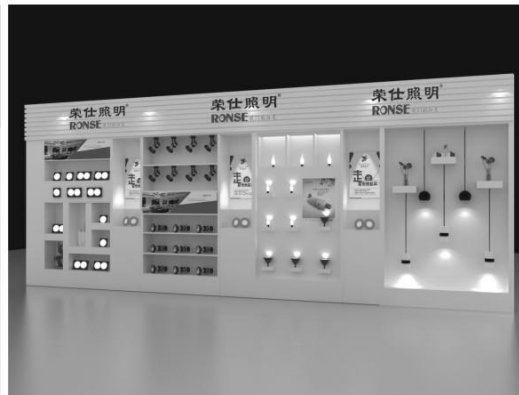

终端形象 IMAG STORE

销售商店直接访问广告形象,品牌形象,引发消费者在短时间内品牌感性认识。统一品牌形象的每个商店门头,形象,形象,展览板,天花板必须统一风格。商店使用简洁明快、安全、实用的装饰风格

Products and technological innovation is the core of the enterprise innovation, is the tireless pursuit; integrating product and technology development into a whole, meanwhile, both the requirements of customers and the market feasibility are considered to obtain success in business and product innovation.

企业荣誉 ENTERPRISE HONOR

为您提供高质量和高可靠性的产品
**TO PROVIDE YOU WITH
 HIGH QUALITY AND
 HIGH RELIABILITY PRODUCTS**



RoHS认证



CE认证



CCC认证



专利证书



TUV认证



[RONSE] 的理念

光——

对于人类来说是不可缺少的存在。

“光”虽然使我们的生活丰富多彩，但它需要大量的资源，从而带来了节能和环保等诸多课题。

在节能的基础上我们将创造更多——能触动人心的照明环境，这是我们坚持不懈的追求。

有效利用有限能源，同时满足人类的心理和生理需求，并附加上多种可能性和价值，以此不断

创造出新的“光”。

这就是“**RONSE**”的理念。

我们所提倡的“**RONSE**”中，包含着对于美好未来的期待和希望。

创造保护环境、关爱人类的未来之光，朝着无限的可能性——

RONSE 在不断提升。



CATALOGUE

LED 导轨灯系列
LED Track light series

001-036

LED 天花灯系列
LED Ceiling light series

037-044

LED 筒灯系列
LED Down light series

045-056

LED 射灯系列
LED Spotlight series

057-062

LED 象鼻灯系列
LED Trunk lamp series

063-068

LED 格栅射灯系列
LED Grille light series

069-078

LED 明装筒灯系列
LED Surface mounted downlight series

079-084

LED 吊线灯系列
LED Hanging light series

085-090

LED 投光灯系列
LED Flood light series

091-098

LED 工矿灯系列
LED High bay light series

099-100

LED 壁灯系列
LED Wall light series

101-106

LED 草坪灯系列
LED Lawn lamp series

107-110

RONSE

LED Track Light Series



2.4G Smart Wireless Dimming LED Lighting



LED 调光调色触摸控制面板
CCT and Dimming Control Panel

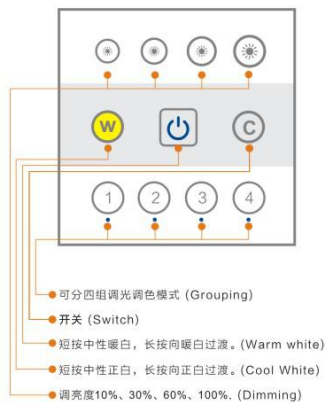

LED 调光触摸控制面板
Dimming Control Panel

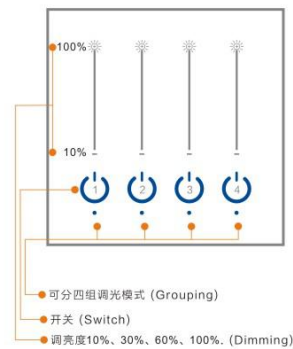

LED照明效果
防眩效果显著,
被照物品周围没有眩光。

传统金卤灯照明效果
没有防眩光设计
被照物品周围有明显的眩光

防眩光的光线设计

眩光, 一直是困扰照明设计及商家的难题。LED照明运用最先进的光学设计理念, 有效地实现光照分布和眩光控制。同传统的光学相比, 我们的光学系统解决了光线从灯杯外漏而产生眩光。影响视觉舒适的问题。

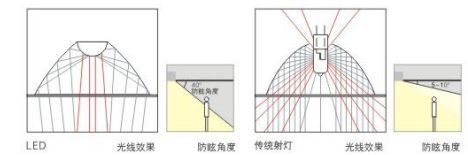

COB导轨灯·银河系列



Model: GD18C10A

灯具功率/Light Power: COB 10W
输入电压/Input Voltage: AC180-240V 50Hz/60Hz
光通量/Luminous Flux: 800LM
显色指数/CRI: Ra≥80
色温/Color Temperature: 3000K/4000K/6000K

内箱尺寸/Box size: 85x60x235mm
外箱尺寸/ Carton size: 620x270x255mm
包装数/Qty/Ctn: 30PCS
灯体材质/Material: 铝/Aluminum



Model: GD18C20A

灯具功率/Light Power: COB 20W
输入电压/Input Voltage: AC180-240V 50Hz/60Hz
光通量/Luminous Flux: 1600LM
显色指数/CRI: Ra≥80
色温/Color Temperature: 3000K/4000K/6000K

内箱尺寸/Box size: 85x85x250mm
外箱尺寸/ Carton size: 530x355x270mm
包装数/Qty/Ctn: 24PCS
灯体材质/Material: 铝/Aluminum



Model: GD18C30A

灯具功率/Light Power: COB 30W
输入电压/Input Voltage: AC180-240V 50Hz/60Hz
光通量/Luminous Flux: 2400LM
显色指数/CRI: Ra≥80
色温/Color Temperature: 3000K/4000K/6000K

内箱尺寸/Box size: 95x95x285mm
外箱尺寸/ Carton size: 495x395x305mm
包装数/Qty/Ctn: 20PCS
灯体材质/Material: 铝/Aluminum



Model: GD18C40A

灯具功率/Light Power: COB 40W
输入电压/Input Voltage: AC180-240V 50Hz/60Hz
光通量/Luminous Flux: 3200LM
显色指数/CRI: Ra≥80
色温/Color Temperature: 3000K/4000K/6000K

内箱尺寸/Box size: 105x100.5x285mm
外箱尺寸/ Carton size: 545x320x305mm
包装数/Qty/Ctn: 15PCS
灯体材质/Material: 铝/Aluminum



Model: GD18H40A

灯具功率/Light Power: COB 40W
输入电压/Input Voltage: AC180-240V 50Hz/60Hz
光通量/Luminous Flux: 3200LM
显色指数/CRI: Ra≥80
色温/Color Temperature: 3000K/4000K/6000K

内箱尺寸/Box size: 170x115x250mm
外箱尺寸/ Carton size: 595x355x270mm
包装数/Qty/Ctn: 10PCS
灯体材质/Material: 铝/Aluminum



Model: GD18H50A

灯具功率/Light Power: COB 50W
输入电压/Input Voltage: AC180-240V 50Hz/60Hz
光通量/Luminous Flux: 4000LM
显色指数/CRI: Ra≥80
色温/Color Temperature: 3000K/4000K/6000K

内箱尺寸/Box size: 162x140x220mm
外箱尺寸/ Carton size: 580x340x240mm
包装数/Qty/Ctn: 8PCS
灯体材质/Material: 铝/Aluminum



Model: GD18H60A

灯具功率/Light Power: COB 60W
输入电压/Input Voltage: AC180-240V 50Hz/60Hz
光通量/Luminous Flux: 4800LM
显色指数/CRI: Ra≥80
色温/Color Temperature: 3000K/4000K/6000K

内箱尺寸/Box size: 162x140x220mm
外箱尺寸/ Carton size: 580x340x240mm
包装数/Qty/Ctn: 8PCS
灯体材质/Material: 铝/Aluminum





Model: GD18B50C

灯具功率/Light Power: COB 50W
 输入电压/Input Voltage: AC180~240V 50Hz/60Hz
 光通量/Luminous Flux: 4000LM
 显色指数/CRI: Ra≥80
 色温/Color Temperature: 3000K/4000K/6000K

内箱尺寸/Box size: 585x65x115mm
 外箱尺寸/ Carton size: 600x345x250mm
 包装数/Qty/Ctn: 10PCS
 灯体材质/Material: 铝/Aluminum



Model: GD18B40S

灯具功率/Light Power: SMD 40W
 输入电压/Input Voltage: AC180~240V 50Hz/60Hz
 光通量/Luminous Flux: 3200LM
 显色指数/CRI: Ra≥80
 色温/Color Temperature: 3000K/4000K/6000K

内箱尺寸/Box size: 515*65*105mm
 外箱尺寸/ Carton size: 530*345*230mm
 包装数/Qty/Ctn: 10PCS
 灯体材质/Material: 铝/Aluminum



Model: GD17J30C

灯具功率/Light Power: COB 30W/40W
 输入电压/Input Voltage: AC180~240V 50Hz/60Hz
 光通量/Luminous Flux: 2400LM/3200LM
 显色指数/CRI: Ra≥80
 色温/Color Temperature: 3000K/4000K/6000K

内箱尺寸/Box size: 110x110x265mm
 外箱尺寸/ Carton size: 570x345x285mm
 包装数/Qty/Ctn: 15PCS
 灯体材质/Material: 铝/Aluminum



Model: GD17K40B

灯具功率/Light Power: COB 30W/40W
 输入电压/Input Voltage: AC180~240V 50Hz/60Hz
 光通量/Luminous Flux: 2700LM/3600LM
 显色指数/CRI: Ra≥80
 色温/Color Temperature: 3000K/4000K/6000K

内箱尺寸/Box size: 215x110x240mm
 外箱尺寸/ Carton size: 570x445x260mm
 包装数/Qty/Ctn: 10PCS
 灯体材质/Material: 铝/Aluminum

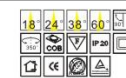

Model: GD17K30A

灯具功率/Light Power: COB 30W/40W
 输入电压/Input Voltage: AC180~240V 50Hz/60Hz
 光通量/Luminous Flux: 2700LM/3600LM
 显色指数/CRI: Ra≥80
 色温/Color Temperature: 3000K/4000K/6000K

内箱尺寸/Box size: 215x110x240mm
 外箱尺寸/ Carton size: 570x445x260mm
 包装数/Qty/Ctn: 10PCS
 灯体材质/Material: 铝/Aluminum





Model: GD16H40C

灯具功率/Light Power: COB 40W
输入电压/Input Voltage: AC180~240V 50Hz/60Hz
光通量/Luminous Flux: 3200LM
显色指数/CRI: Ra≥80
色温/Color Temperature: 3000K/4000K/6000K

内箱尺寸/Box size: 170x115x250mm
外箱尺寸/ Carton size: 595x355x270mm
包装数/Qty/Ctn: 10PCS
灯体材质/Material: 铝/Aluminum



Model: GD16H50D

灯具功率/Light Power: COB 50W
输入电压/Input Voltage: AC180~240V 50Hz/60Hz
光通量/Luminous Flux: 4000LM
显色指数/CRI: Ra≥80
色温/Color Temperature: 3000K/4000K/6000K

内箱尺寸/Box size: 162x140x220mm
外箱尺寸/ Carton size: 580x340x240mm
包装数/Qty/Ctn: 8PCS
灯体材质/Material: 铝/Aluminum



Model: GD16H60E

灯具功率/Light Power: COB 60W
输入电压/Input Voltage: AC180~240V 50Hz/60Hz
光通量/Luminous Flux: 4200LM
显色指数/CRI: Ra≥80
色温/Color Temperature: 3000K/4000K/6000K

内箱尺寸/Box size: 162x140x220mm
外箱尺寸/ Carton size: 580x340x240mm
包装数/Qty/Ctn: 8PCS
灯体材质/Material: 铝/Aluminum

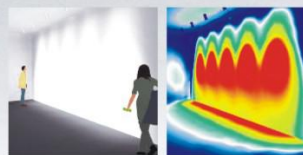
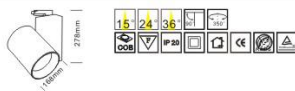

洗点是一个焦点，是专门设计的，拥有宽效的洗涤显示墙。结合一个优秀的设计与开发利用的LED安装反射专有的光学设计，照在被照物上：高显色性、无重影、穿透力强，被照物清晰、明亮，对商品色泽，表面肌理有着极强的自然还原性，更能吸引顾客的目光。

Model: GD16R30A

灯具功率/Light Power: COB 30W
输入电压/Input Voltage: AC180~240V 50Hz/60Hz
光通量/Luminous Flux: 2400LM
显色指数/CRI: Ra≥80
色温/Color Temperature: 3000K/4000K/6000K

内箱尺寸/Box size: 168x105x250mm
外箱尺寸/ Carton size: 545x350x270mm
包装数/Qty/Ctn: 10PCS
灯体材质/Material: 铝/Aluminum

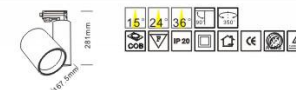

Model: GD16R40A

灯具功率/Light Power: COB 40W
输入电压/Input Voltage: AC180~240V 50Hz/60Hz
光通量/Luminous Flux: 3200LM
显色指数/CRI: Ra≥80
色温/Color Temperature: 3000K/4000K/6000K

内箱尺寸/Box size: 168x105x250mm
外箱尺寸/ Carton size: 545x350x270mm
包装数/Qty/Ctn: 10PCS
灯体材质/Material: 铝/Aluminum





简约风尚，国际典范

Contracted fashion, the international model

适用场所/Application places:
商场、展览厅、高档服装店、珠宝首饰连锁店、精品店等照明应用;
Shopping mall, Hotel, Exhibition Hall, Fashion garment shop, jewelry chain store, outique shop etc.



Model: GD17L10B

灯具功率/Light Power: COB 10W
输入电压/Input Voltage: AC180-240V 50Hz/60Hz
光通量/Luminous Flux: 800LM
显色指数/CRI: Ra≥80
色温/Color Temperature: 3000K/4000K/6000K

内箱尺寸/Box size: 85x85x245mm
外箱尺寸/ Carton size: 530x355x265mm
包装数/Qty/Ctn: 24PCS
灯体材质/Material: 铝/Aluminum

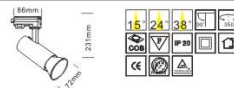

Model: GD17L20C

灯具功率/Light Power: COB 20W
输入电压/Input Voltage: AC180-240V 50Hz/60Hz
光通量/Luminous Flux: 1600LM
显色指数/CRI: Ra≥80
色温/Color Temperature: 3000K/4000K/6000K

内箱尺寸/Box size: 85x85x265mm
外箱尺寸/ Carton size: 530x355x285mm
包装数/Qty/Ctn: 24PCS
灯体材质/Material: 铝/Aluminum



Model: GD17L10A

灯具功率/Light Power: COB 10W/20W
输入电压/Input Voltage: AC180-240V 50Hz/60Hz
光通量/Luminous Flux: 800LM/1600LM
显色指数/CRI: Ra≥80
色温/Color Temperature: 3000K/4000K/6000K

内箱尺寸/Box size: 185x95x210mm
外箱尺寸/ Carton size: 495x385x230mm
包装数/Qty/Ctn: 10PCS
灯体材质/Material: 铝/Aluminum

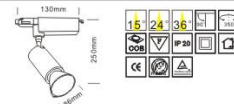

Model: GD18R15A

灯具功率/Light Power: COB 15W
输入电压/Input Voltage: AC180-240V 50Hz/60Hz
光通量/Luminous Flux: 1200LM
显色指数/CRI: Ra≥80
色温/Color Temperature: 3000K/4000K/6000K

内箱尺寸/Box size: 140x80x265mm
外箱尺寸/ Carton size: 500x295x285mm
包装数/Qty/Ctn: 12PCS
灯体材质/Material: 铝/Aluminum



Model: GD18R20B

灯具功率/Light Power: COB 20W
输入电压/Input Voltage: AC180-240V 50Hz/60Hz
光通量/Luminous Flux: 1600LM
显色指数/CRI: Ra≥80
色温/Color Temperature: 3000K/4000K/6000K

内箱尺寸/Box size: 140x80x310mm
外箱尺寸/ Carton size: 500x295x320mm
包装数/Qty/Ctn: 12PCS
灯体材质/Material: 铝/Aluminum



Model: GD18R30C

灯具功率/Light Power: COB 30W
输入电压/Input Voltage: AC180-240V 50Hz/60Hz
光通量/Luminous Flux: 2400LM
显色指数/CRI: Ra≥80
色温/Color Temperature: 3000K/4000K/6000K

内箱尺寸/Box size: 140x80x370mm
外箱尺寸/ Carton size: 500x295x390mm
包装数/Qty/Ctn: 12PCS
灯体材质/Material: 铝/Aluminum

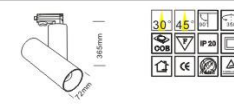



主要应用：大型商业连锁店、百货商店、商铺、DIY店、展示厅、酒店、博物馆、餐厅、酒吧。
强调较高的照明对比度，突出重点区域。
Main application: large commercial chain stores, department stores, small shops, DIY shops, exhibition hall, museum, hotel, restaurant, bar. Emphasize the high lighting contrast, highlight key areas.



Model: GD16S10B

灯具功率/Light Power: COB 10W
输入电压/Input Voltage: AC180-240V 50Hz/60Hz
光通量/Luminous Flux: 800LM
显色指数/CRI: Ra>=80
色温/Color Temperature: 3000K/4000K/6000K

内箱尺寸/Box size: 80x80x510mm
外箱尺寸/Carton size: 420x335x510mm
包装数/Qty/Ctn: 20PCS
灯体材质/Material: 铝/Aluminum

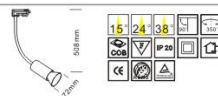

Model: GD16S10A

灯具功率/Light Power: COB 10W
输入电压/Input Voltage: AC180-240V 50Hz/60Hz
光通量/Luminous Flux: 800LM
显色指数/CRI: Ra>=80
色温/Color Temperature: 3000K/4000K/6000K

内箱尺寸/Box size: 80x80x510mm
外箱尺寸/Carton size: 420x335x510mm
包装数/Qty/Ctn: 20PCS
灯体材质/Material: 铝/Aluminum

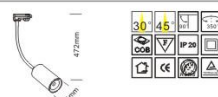



专利产品
Patented products



20° 40° 60°



Model: GD16P10A

灯具功率/Light Power: COB 10W
输入电压/Input Voltage: AC220-265V 50Hz/60Hz
光通量/Luminous Flux: 800LM
显色指数/CRI: Ra≥80
色温/CCT: 3000K/4000K/6000K

内箱尺寸/Box size: 105x75x265mm
外箱尺寸/ Carton size: 620x330x285mm
包装数/Qty/Ctn: 24PCS
灯体材质/Material: 铝/Aluminum



Model: GD16P20B

灯具功率/Light Power: COB 20W
输入电压/Input Voltage: AC220-265V 50Hz/60Hz
光通量/Luminous Flux: 1600LM
显色指数/CRI: Ra≥80
色温/CCT: 3000K/4000K/6000K

内箱尺寸/Box size: 98x98x275mm
外箱尺寸/ Carton size: 510x310x295mm
包装数/Qty/Ctn: 15PCS
灯体材质/Material: 铝/Aluminum



Model: GD16P30C

灯具功率/Light Power: COB30W/40W
输入电压/Input Voltage: AC220-265V 50Hz/60Hz
光通量/Luminous Flux: 2400/3200LM
显色指数/CRI: Ra≥80
色温/CCT: 3000K/4000K/6000K

内箱尺寸/Box size: 105x100.5x300mm
外箱尺寸/ Carton size: 545x316x320mm
包装数/Qty/Ctn: 15PCS
灯体材质/Material: 铝/Aluminum



专利产品
Patented products



20° 40° 60°



Model: RS-2298A

灯具功率/Light Power: COB 30/40W
输入电压/Input Voltage: AC220-265V 50Hz/60Hz
光通量/Luminous Flux: 2400/3200LM
显色指数/CRI: Ra≥80
色温/CCT: 3000K/4000K/6000K

内箱尺寸/Box size: 125x125x300mm
外箱尺寸/ Carton size: 520x265x320mm
包装数/Qty/Ctn: 8PCS
灯体材质/Material: 铝/Aluminum



Model: RS-2298B

灯具功率/Light Power: COB 30/40W
输入电压/Input Voltage: AC220-265V 50Hz/60Hz
光通量/Luminous Flux: 2400/3200LM
显色指数/CRI: Ra≥80
色温/CCT: 3000K/4000K/6000K

内箱尺寸/Box size: 220x125x330mm
外箱尺寸/ Carton size: 520x455x350mm
包装数/Qty/Ctn: 8PCS
灯体材质/Material: 铝/Aluminum



Model: RS-2298C

灯具功率/Light Power: COB 30/40W
输入电压/Input Voltage: AC220-265V 50Hz/60Hz
光通量/Luminous Flux: 2400/3200LM
显色指数/CRI: Ra≥80
色温/CCT: 3000K/4000K/6000K

内箱尺寸/Box size: 170x125x340mm
外箱尺寸/ Carton size: 520x355x360mm
包装数/Qty/Ctn: 8PCS
灯体材质/Material: 铝/Aluminum





主要应用：大型商业连锁店、百货商店、商铺、DIY店、展示厅、酒店、博物馆、餐厅、酒吧。
 强调较高的照明对比度，突出重点区域。
 Main application: large commercial chain stores, department stores, small shops, DIY shops, exhibition hall, museum, hotel, restaurant, bar. Emphasize the high lighting contrast, highlight key areas.

可选配件 Optional accessories



透镜 Optical lens
 蜂窝网 Honey comb
 遮光罩 Light Hood

Model: GD16J30A

灯具功率/Light Power: COB 30W
 输入电压/Input Voltage: AC220-265V 50Hz/60Hz
 光通量/Luminous Flux: 2400LM
 显色指数/CRI: Ra≥80
 色温/Color Temperature: 3000K/4000K/6000K

内箱尺寸/Box size: 95x95x260mm
 外箱尺寸/Carton size: 495x300x280mm
 包装数/Qty/Ctn: 15PCS
 灯体材质/Material: 铝/Aluminum



简约风尚，国际典范

Contracted fashion, the international model

适用场所/Application places:

商场、展览厅、高档服装店、珠宝首饰连锁店、精品店等照明应用；
 Shopping mall, Hotel, Exhibition Hall, Fashion garment shop, jewelry chain store, outique shop etc.



Model: GD03F30C

灯具功率/Light Power: COB 30W
 输入电压/Input Voltage: AC220-265V 50Hz/60Hz
 光通量/Luminous Flux: 2400LM
 显色指数/CRI: Ra≥80
 色温/Color Temperature: 3000K/4000K/6000K

内箱尺寸/Box size: 216x95x215mm
 外箱尺寸/Carton size: 495x445x235mm
 包装数/Qty/Ctn: 10PCS
 灯体材质/Material: 铝/Aluminum

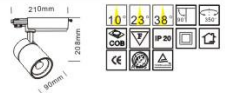

Model: GD02L30C

灯具功率/Light Power: COB 30W
 输入电压/Input Voltage: AC220-265V 50Hz/60Hz
 光通量/Luminous Flux: 2400LM
 显色指数/CRI: Ra≥80
 色温/Color Temperature: 3000K/4000K/6000K

内箱尺寸/Box size: 100x100x270mm
 外箱尺寸/Carton size: 520x315x290mm
 包装数/Qty/Ctn: 15PCS
 灯体材质/Material: 铝/Aluminum



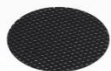

Honey comb

Model: GD16G40C

灯具功率/Light Power: COB 40W
 输入电压/Input Voltage: AC220-265V 50Hz/60Hz
 光通量/Luminous Flux: 3200LM
 显色指数/CRI: Ra>=80
 色温/Color Temperature: 3000K/4000K/6000K

内箱尺寸/Box size: 162x140x220mm
 外箱尺寸/ Carton size: 580x340x240mm
 包装数/Qty/Ctn: 8PCS
 灯体材质/Material: 铝/Aluminum



Model: GD16G50C

灯具功率/Light Power: COB 50W
 输入电压/Input Voltage: AC220-265V 50Hz/60Hz
 光通量/Luminous Flux: 4000LM
 显色指数/CRI: Ra>=80
 色温/Color Temperature: 3000K/4000K/6000K

内箱尺寸/Box size: 170.5x146.5x225mm
 外箱尺寸/ Carton size: 535x310x245mm
 包装数/Qty/Ctn: 6PCS
 灯体材质/Material: 铝/Aluminum





主要应用: 大型商业连锁店、百货商店、商铺、DIY店、展示厅、酒店、博物馆、餐厅、酒吧。强调较高的照明对比度, 突出重点区域。

Main application: large commercial chain stores, department stores, small shops, DIY shops, exhibition hall, museum, hotel, restaurant, bar. Emphasize the high lighting contrast, highlight key areas.



Model: GD16H30A

灯具功率/Light Power: COB 30W
输入电压/Input Voltage: AC220~265V 50Hz/60Hz
光通量/Luminous Flux: 2700LM
显色指数/CRI: Ra>=80
色温/CCT: 3000K/4000K/6000K

内箱尺寸/Box size: 150x100x245mm
外箱尺寸/Carton size: 545x315x265mm
包装数/Qty/Ctn: 10PCS
灯体材质/Material: 铝/Aluminium



Model: GD16H30B

灯具功率/Light Power: COB 30W
输入电压/Input Voltage: AC220~265V 50Hz/60Hz
光通量/Luminous Flux: 2700LM
显色指数/CRI: Ra>=80
色温/CCT: 3000K/4000K/6000K

内箱尺寸/Box size: 160x105x245mm
外箱尺寸/Carton size: 545x335x265mm
包装数/Qty/Ctn: 10PCS
灯体材质/Material: 铝/Aluminium



Model: GD16H40A

灯具功率/Light Power: COB 40W
输入电压/Input Voltage: AC220~265V 50Hz/60Hz
光通量/Luminous Flux: 3600LM
显色指数/CRI: Ra>=80
色温/CCT: 3000K/4000K/6000K

内箱尺寸/Box size: 155x115x245mm
外箱尺寸/Carton size: 595x325x265mm
包装数/Qty/Ctn: 10PCS
灯体材质/Material: 铝/Aluminium



Model: GD16H40B

灯具功率/Light Power: COB 40W
输入电压/Input Voltage: AC220~265V 50Hz/60Hz
光通量/Luminous Flux: 3600LM
显色指数/CRI: Ra>=80
色温/CCT: 3000K/4000K/6000K

内箱尺寸/Box size: 170x115x245mm
外箱尺寸/Carton size: 595x355x265mm
包装数/Qty/Ctn: 10PCS
灯体材质/Material: 铝/Aluminium



RONSE lighting



Elegant texture,
delicate and easy
典雅质感，精致大方

产品特性/Product features:

灯体使用低热阻铝材数控车制而成，采用对流散热设计，多种角度可调节；表面静电喷粉处理，附着性好，产品外形美观流畅；并设有安全定位点，防止无序调节产生的电线缠绕导致的安全隐患；选用集成式COB光源，显色指数Ra≥80，真实还原色彩；采用恒流隔离驱动电源，光线无频闪，有效保护眼睛视力；

The lamp body adopts aluminum with low-thermal resistance and made by CNC machine, a variety of angle can be adjustable; Surface process with electrostatic powder spraying, protect the body color effectively, appearance will be beautiful and fluent. Setting the safe point, prevent disorderly adjustment of wire would lead to safety hazard; Choose COB source that light efficiency more than 80 lm/W, to restore true color. Driven by constant current isolated power supply, no strobeoscopic light, effectively protecting eyesight.



Honey comb

Model: GD16M30A

灯具功率/Light Power: COB 30W
输入电压/Input Voltage: AC220-265V 50Hz/60Hz
光通量/Luminous Flux: 2700LM
显色指数/CRI: Ra≥80
色温/CCT: 3000K/4000K/6000K

内箱尺寸/Box size: 147x105x225mm
外箱尺寸/ Carton size: 545x310x245mm
包装数/Qty/Ctn: 10PCS
灯体材质/Material: 铝/Aluminum



导轨灯系列
Track Light Series



铬
Plated chrome

枪黑
Plated black

玫瑰金
Plated gold



Model: GD16C10A

灯具功率/Light Power: COB 10W
输入电压/Input Voltage: AC220-265V 50Hz/60Hz
光通量/Luminous Flux: 900LM
显色指数/CRI: Ra≥80
色温/CCT: 3000K/4000K/6000K

内箱尺寸/Box size: 85x85x245mm
外箱尺寸/ Carton size: 530x355x265mm
包装数/Qty/Ctn: 24PCS
灯体材质/Material: 铝/Aluminum

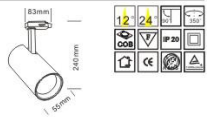

Model: GD16D20A

灯具功率/Light Power: COB 20W
输入电压/Input Voltage: AC220-265V 50Hz/60Hz
光通量/Luminous Flux: 1800LM
显色指数/CRI: Ra≥80
色温/CCT: 3000K/4000K/6000K

内箱尺寸/Box size: 85x85x265mm
外箱尺寸/ Carton size: 530x355x285mm
包装数/Qty/Ctn: 24PCS
灯体材质/Material: 铝/Aluminum

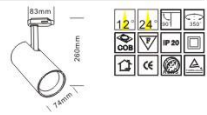

Model: GD16E30A

灯具功率/Light Power: COB 30W
输入电压/Input Voltage: AC220-265V 50Hz/60Hz
光通量/Luminous Flux: 2700LM
显色指数/CRI: Ra≥90
色温/CCT: 3000K/4000K/6000K

内箱尺寸/Box size: 100x95x295mm
外箱尺寸/ Carton size: 520x300x315mm
包装数/Qty/Ctn: 15PCS
灯体材质/Material: 铝/Aluminum

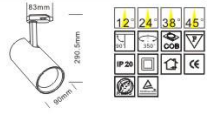

Honey comb



简约风尚，国际典范
Contracted fashion, the international model

适用场所/Application places:
商场、展览厅、高档服装店、珠宝首饰连锁店、精品店等照明应用;
Shopping mall, Hotel, Exhibition Hall, Fashion garment shop, jewelry chain store, outlque shop etc.

Model: GD16A10C

灯具功率/Light Power: COB 10/15W/20W
输入电压/Input Voltage: AC220-265V 50Hz/60Hz
光通量/Luminous Flux: 800/1200LM
显色指数/CRI: Ra≥80
色温/Color Temperature: 3000K/4000K/6000K

内箱尺寸/Box size: 128x95x190mm
外箱尺寸/Carlton size: 495x270x210mm
包装数/Qty/Ctn: 10PCS
灯体材质/Material: 铝/Aluminum



GD16B30A

GD16B30C

GD16B50C

Model: GD16B30A

灯具功率/Light Power: COB 30W
输入电压/Input Voltage: AC220-265V 50Hz/60Hz
光通量/Luminous Flux: 2700LM
显色指数/CRI: Ra≥80
色温/Color Temperature: 3000K/4000K/6000K

内箱尺寸/Box size: 150x105x255mm
外箱尺寸/Carlton size: 545x320x275mm
包装数/Qty/Ctn: 10PCS
灯体材质/Material: 铝/Aluminum



Honey comb

Model: GD16B30C

灯具功率/Light Power: COB 30W
输入电压/Input Voltage: AC220-265V 50Hz/60Hz
光通量/Luminous Flux: 2400LM
显色指数/CRI: Ra≥80
色温/Color Temperature: 3000K/4000K/6000K

内箱尺寸/Box size: 150x105x255mm
外箱尺寸/Carlton size: 545x320x275mm
包装数/Qty/Ctn: 10PCS
灯体材质/Material: 铝/Aluminum



Honey comb

Model: GD16B50C

灯具功率/Light Power: COB 50W
输入电压/Input Voltage: AC220-265V 50Hz/60Hz
光通量/Luminous Flux: 4000LM
显色指数/CRI: Ra≥80
色温/Color Temperature: 3000K/4000K/6000K

内箱尺寸/Box size: 166x105x270mm
外箱尺寸/Carlton size: 595x345x290mm
包装数/Qty/Ctn: 10PCS
灯体材质/Material: 铝/Aluminum

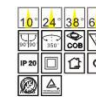

Honey comb



简约的造型设计，灯外观比例完美协调、精美。
Simple structure harmonious body in proportion, exquisite appearance.

产品特性/Product features:

灯体使用低热阻铝材数控车制而成，采用对流散热设计，多种角度可调节；表面静电喷粉处理，附着性好，产品外形美观流畅；并设有安全定位点，防止无序调节产生的电线缠绕导致的安全隐患；选用集成式COB光源，显色指数Ra≥80，真实还原色彩；采用恒流隔离驱动电源，光线无频闪，有效保护眼睛视力；

The lamp body adopts aluminum with low-thermal resistance and made by CNC machine, a variety of angle can be adjustable. Surface process with electrostatic powder spraying, protect the body color effectively, appearance will be beautiful and fluent. Setting the safe point, prevent disorderly adjustment of wire wound lead to safety hazard; Choose COB source that light efficiency more than 80 lm/W, to restore true color. Driven by constant current isolated power supply, no stroboscopic light, effectively protecting eyesight.



Honey comb

Model: GD02F30A

灯具功率/Light Power: COB 30W
输入电压/Input Voltage: AC220~265V 50Hz/60Hz
光通量/Luminous Flux: 2400LM
显色指数/CRI: Ra≥80
色温/Color Temperature: 3000K/4000K/6000K

内箱尺寸/Box size: 205x105x255mm
外箱尺寸/Carton size: 495x445x235mm
包装数/Qty/Ctn: 10PCS
灯体材质/Material: 铝/Aluminum



Model: RS-2271A

灯具功率/Light Power: COB 10W/15W
输入电压/Input Voltage: AC180~240V 50Hz/60Hz
光通量/Luminous Flux: 800LM/1200LM
显色指数/CRI: Ra≥80
色温/Color Temperature: 3000K/4000K/6000K

内箱尺寸/Box size: 125x85x210mm
外箱尺寸/Carton size: 530x265x230mm
包装数/Qty/Ctn: 12PCS
灯体材质/Material: 铝/Aluminum

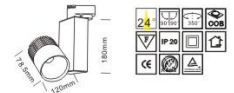

Model: RS-2271B

灯具功率/Light Power: COB 20W
输入电压/Input Voltage: AC180~240V 50Hz/60Hz
输出电压/Output voltage: DC30~37V 550mA
光通量/Luminous Flux: 1600LM
显色指数/CRI: Ra≥80
色温/Color Temperature: 3000K/4000K/6000K

内箱尺寸/Box size: 160x105x245mm
外箱尺寸/Carton size: 545x335x265mm
包装数/Qty/Ctn: 10PCS
灯体材质/Material: 铝/Aluminum

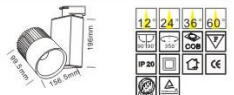

Model: RS-2271C

灯具功率/Light Power: COB 30W
输入电压/Input Voltage: AC180~240V 50Hz/60Hz
光通量/Luminous Flux: 2400LM
显色指数/CRI: Ra≥80
色温/Color Temperature: 3000K/4000K/6000K

内箱尺寸/Box size: 160x105x245mm
外箱尺寸/Carton size: 545x335x265mm
包装数/Qty/Ctn: 10PCS
灯体材质/Material: 铝/Aluminum

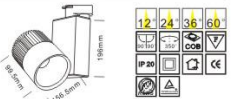

主要应用：大型商业连锁店、百货商店、商铺、DIY店、展示厅、酒店、博物馆、餐厅、酒吧。强调较高的照明对比度，突出重点区域。
Main application: large commercial chain stores, department stores, small shops, DIY shops, exhibition hall, museum, hotel, restaurant, bar. Emphasize the high lighting contrast, highlight key areas.



Model: GD01G07C

灯具功率/Light Power: COB 7W
输入电压/Input Voltage: AC220-265V 50Hz/60Hz
光通量/Luminous Flux: 600LM
显色指数/CRI: Ra>=80
色温/Color Temperature: 3000K/4000K/6000K

内箱尺寸/Box size: 100x60x170mm
外箱尺寸/ Carton size: 620x320x360mm
包装数/Qty/Ctn: 60PCS
灯体材质/Material: 铝/Aluminum

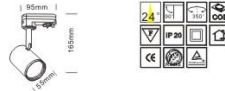

Model: GD01H07B

灯具功率/Light Power: COB 7W
输入电压/Input Voltage: AC220-265V 50Hz/60Hz
光通量/Luminous Flux: 560LM
显色指数/CRI: Ra>=80
色温/Color Temperature: 3000K/4000K/6000K

内箱尺寸/Box size: 120x120x60mm
外箱尺寸/ Carton size: 620x255x320mm
包装数/Qty/Ctn: 50PCS
灯体材质/Material: 铝/Aluminum



Model: GD01H07C

灯具功率/Light Power: COB 7W
输入电压/Input Voltage: AC220-265V 50Hz/60Hz
输出电压/Output voltage: DC21V 300mA
光通量/Luminous Flux: 560LM
显色指数/CRI: Ra>=80
色温/Color Temperature: 3000K/4000K/6000K

内箱尺寸/Box size: 120x120x60mm
外箱尺寸/ Carton size: 620x255x320mm
包装数/Qty/Ctn: 60PCS
灯体材质/Material: 铝/Aluminum



Model: GD02F30C

灯具功率/Light Power: COB 30W
输入电压/Input Voltage: AC220-240V 50Hz/60Hz
光通量/Luminous Flux: 2400LM
显色指数/CRI: Ra>=80
色温/Color Temperature: 3000K/4000K/5500K

内箱尺寸/Box size: 215x95x215mm
外箱尺寸/ Carton size: 495x445x235mm
包装数/Qty/Ctn: 10PCS
灯体材质/Material: 铝/Aluminum

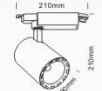

Model: GD15H30F

灯具功率/Light Power: COB 30W
输入电压/Input Voltage: AC220-240V 50Hz/60Hz
光通量/Luminous Flux: 2400LM
显色指数/CRI: Ra>=80
色温/Color Temperature: 3000K/4000K/5500K

内箱尺寸/Box size: 250x220x98mm
外箱尺寸/ Carton size: 520x455x216mm
包装数/Qty/Ctn: 8PCS
灯体材质/Material: 铝/Aluminum



Model: RS-2286A

灯具功率/Light Power: COB 45W
输入电压/Input Voltage: AC180-240V 50Hz/60Hz
光通量/Luminous Flux: 3600LM
显色指数/CRI: Ra>=80
色温/Color Temperature: 3000K/4000K/6000K

内箱尺寸/Box size: 300x230x105mm
外箱尺寸/ Carton size: 480x315x335mm
包装数/Qty/Ctn: 6PCS
灯体材质/Material: 铝/Aluminum





节能、高亮度、长寿命

Energy Saving, High Brightness, Long Lifetime

主要应用：大型商业连锁店、百货商店、商铺、DIY店、展示厅、酒店、博物馆、餐厅、酒吧。强调较高的照明对比度，突出重点区域。
Main application: large commercial chain stores, department stores, small shops, DIY shops, exhibition hall, museum, hotel, restaurant, bar. Emphasize the high lighting contrast, highlight key areas.



Model:GD16D30A

灯具功率/Light Power: COB 30W
输入电压/Input Voltage: AC180~240V 50Hz/60Hz
光通量/Luminous Flux: 2400LM
显色指数/CRI: Ra≥80
色温/Color Temperature: 3000K/4000K/6000K

内箱尺寸/Box size: 160x105x240mm
外箱尺寸/Carton size: 545x335x260mm
包装数/Qty/Ctn: 10PCS
灯体材质/Material: 铝/Aluminum

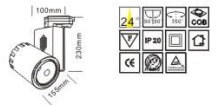

Model: GD16D70A

灯具功率/Light Power: COB 70W
输入电压/Input Voltage: AC220~240V 50Hz/60Hz
光通量/Luminous Flux: 6500LM
显色指数/CRI: Ra≥80
色温/Color Temperature: 3000K/4000K/5500K

内箱尺寸/Box size: 250x220x98mm
外箱尺寸/Carton size: 520x455x216mm
包装数/Qty/Ctn: 8PCS
灯体材质/Material: 铝/Aluminum





至臻品质、视界巅峰 To become the top quality

主要运用：大型商业连锁店、百货商店、商铺、DIY店、展示厅、酒店、博物馆、餐厅、酒吧。强调较高的照明对比度，突出重点区域。
Main application: large commercial chain stores, department stores, small shops, DIY shops, exhibition hall, museum, hotel, restaurant, bar. Emphasize the high lighting contrast, highlight key areas.

Model: RS-2252C

灯具功率/Light Power: COB 10W
输入电压/Input Voltage: AC180-240V 50Hz/60Hz
光通量/Luminous Flux: 800LM
显色指数/CRI: Ra≥80
色温/Color Temperature: 3000K/4000K/6000K

内箱尺寸/Box size: 90x90x235mm
外箱尺寸/ Carton size: 470x285x255mm
包装数/Qty/Ctn: 15PCS
灯体材质/Material: 铝/Aluminum



Model: RS-2252D

灯具功率/Light Power: COB 20W
输入电压/Input Voltage: AC180-240V 50Hz/60Hz
光通量/Luminous Flux: 1600LM
显色指数/CRI: Ra≥80
色温/Color Temperature: 3000K/4000K/6000K

内箱尺寸/Box size: 105x105x300mm
外箱尺寸/ Carton size: 545x225x320mm
包装数/Qty/Ctn: 10PCS
灯体材质/Material: 铝/Aluminum



Model: RS-2252E

灯具功率/Light Power: COB 30W
输入电压/Input Voltage: AC180-240V 50Hz/60Hz
光通量/Luminous Flux: 2400LM
显色指数/CRI: Ra≥80
色温/Color Temperature: 3000K/4000K/6000K

内箱尺寸/Box size: 105x105x300mm
外箱尺寸/ Carton size: 545x225x320mm
包装数/Qty/Ctn: 10PCS
灯体材质/Material: 铝/Aluminum



Model: RS-2275A

灯具功率/Light Power: COB 10W
输入电压/Input Voltage: AC180-240V 50Hz/60Hz
光通量/Luminous Flux: 800LM
显色指数/CRI: Ra≥80
色温/Color Temperature: 3000K/4000K/6000K

内箱尺寸/Box size: 90x90x235mm
外箱尺寸/ Carton size: 470x285x255mm
包装数/Qty/Ctn: 10PCS
灯体材质/Material: 铝/Aluminum



Model: RS-2275B

灯具功率/Light Power: COB 20W
输入电压/Input Voltage: AC180-240V 50Hz/60Hz
光通量/Luminous Flux: 1600LM
显色指数/CRI: Ra≥80
色温/Color Temperature: 3000K/4000K/6000K

内箱尺寸/Box size: 90x90x235mm
外箱尺寸/ Carton size: 470x285x255mm
包装数/Qty/Ctn: 15PCS
灯体材质/Material: 铝/Aluminum



Model: RS-2275C

灯具功率/Light Power: COB 30W
输入电压/Input Voltage: AC180-240V 50Hz/60Hz
光通量/Luminous Flux: 2400LM
显色指数/CRI: Ra≥80
色温/Color Temperature: 3000K/4000K/6000K

内箱尺寸/Box size: 105x105x270mm
外箱尺寸/ Carton size: 440x225x290mm
包装数/Qty/Ctn: 8PCS
灯体材质/Material: 铝/Aluminum



Model: RS-2275D

灯具功率/Light Power: COB 40W
输入电压/Input Voltage: AC180-240V 50Hz/60Hz
光通量/Luminous Flux: 3200LM
显色指数/CRI: Ra≥80
色温/Color Temperature: 3000K/4000K/6000K

内箱尺寸/Box size: 120x120x300mm
外箱尺寸/ Carton size: 500x255x320mm
包装数/Qty/Ctn: 8PCS
灯体材质/Material: 铝/Aluminum



Model: RS-2275E

灯具功率/Light Power: COB 45W
输入电压/Input Voltage: AC220-240V 50Hz/60Hz
光通量/Luminous Flux: 3600LM
显色指数/CRI: Ra≥80
色温/Color Temperature: 3000K/4000K/6000K

内箱尺寸/Box size: 135x135x355mm
外箱尺寸/ Carton size: 560x285x375mm
包装数/Qty/Ctn: 8PCS
灯体材质/Material: 铝/Aluminum





Model: 2 WIRES TRACK SYSTEM (SINGLE PHASE) 两线路轨

规格/Size: 纯铜线导轨 (国家专利)
颜色选择/Color Select: 白色、黑色、银色 White/black/ silver
箱数/ CTNS: 20支
接线规格/Wire specifications: 一字接、L字接、T字接、十字接

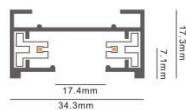

Model: 3 WIRES TRACK SYSTEM 三线路轨

规格/Size: 纯铜线导轨 (国家专利)
颜色选择/Color Select: 白色、黑色、银色 White/black/ silver
箱数/ CTNS: 20支
接线规格/Wire specifications: 一字接、L字接、T字接、十字接

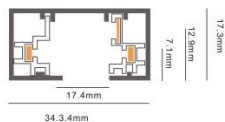

Model: 4 WIRES TRACK SYSTEM (3 CIRCUITS /THREE PHASES) 四线路轨

规格/Size: 纯铜线导轨 (国家专利)
颜色选择/Color Select: 白色、黑色、银色 White/black/ silver
箱数/ CTNS: 20支
接线规格/Wire specifications: 一字接、L字接、T字接、十字接

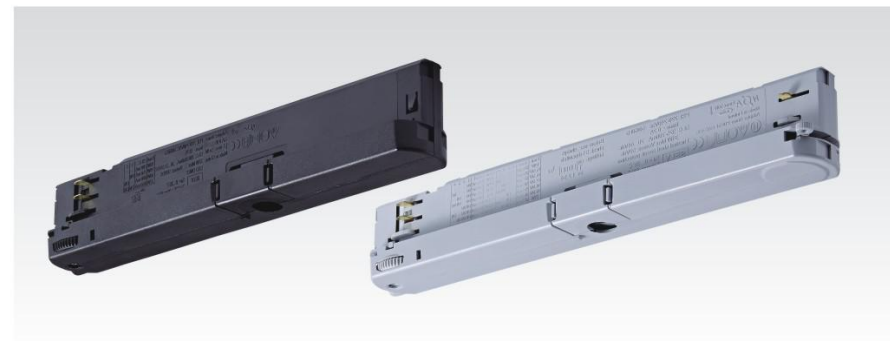
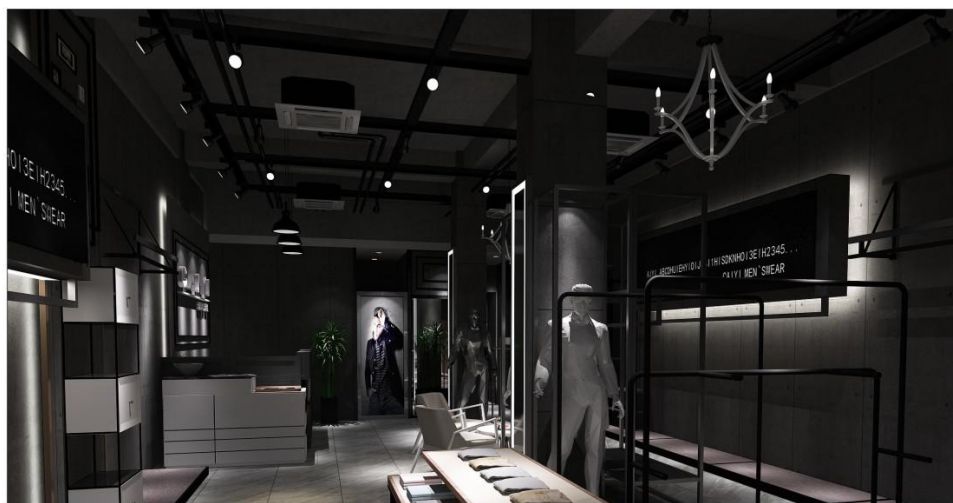
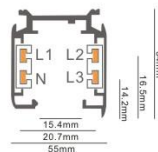

Model: 4 WIRES ADAPTOR 四线导轨头

颜色选择/Color Select: 白色、黑色、银色 White/black/ silver

Model: 6 WIRES ADAPTOR 六线调光导轨头

颜色选择/Color Select: 白色、黑色、银色 White/black/ silver



Model: 2 WIRES ADAPTOR (SINGLE PHASE) 两线导轨头

颜色选择/Color Select: 白色、黑色、银色 White/black/ silver



Model: 3 WIRES ADAPTOR 三线导轨头

颜色选择/Color Select: 白色、黑色、银色 White/black/ silver



Model: 4 WIRES ADAPTOR (3 CIRCUITS /THREE PHASES) A 四线导轨头

颜色选择/Color Select: 白色、黑色、银色 White/black/ silver



Model: 4 WIRES ADAPTOR (3 CIRCUITS /THREE PHASES) B 四线导轨头

颜色选择/Color Select: 白色、黑色、银色 White/black/ silver

RONSE

LED ceiling light series



TH01F05C P 039



TH01B03C P 040



RS-2046 P 042



TH05D03C P 043

COB天花灯·晴空系列

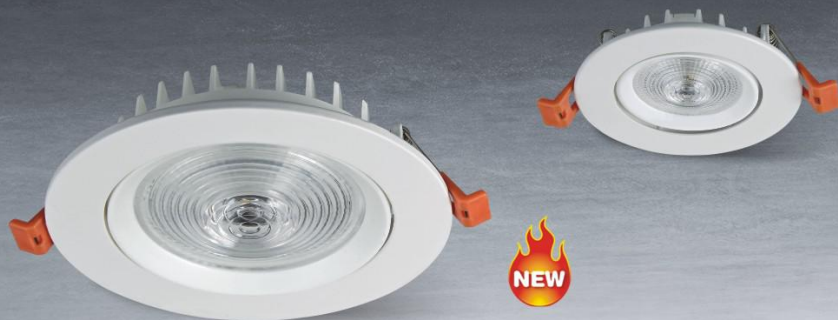

Model: TH01F05C

灯具功率/Light Power: COB 5W
 输入电压/Input Voltage: AC180-240V 50Hz/60Hz
 光通量/Luminous Flux: 400LM
 显色指数/CRI: Ra≥80
 色温/Color Temperature: 3000K/4000K/6000K

内箱尺寸/Box size: 95x95x60mm(两个装)
 外箱尺寸/ Carton size: 495x395x320mm
 包装数/Qty/Ctn: 100PCS
 灯体材质/Material: 铝/Aluminum



Model: TH02F10C

灯具功率/Light Power: COB 10W
 输入电压/Input Voltage: AC180-240V 50Hz/60Hz
 光通量/Luminous Flux: 800LM
 显色指数/CRI: Ra≥80
 色温/Color Temperature: 3000K/4000K/6000K

内箱尺寸/Box size: 115x115x60mm
 外箱尺寸/ Carton size: 595x475x260mm
 包装数/Qty/Ctn: 80PCS
 灯体材质/Material: 铝/Aluminum

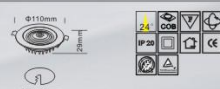

Model: TH03F15C

灯具功率/Light Power: COB 15W
 输入电压/Input Voltage: AC180-240V 50Hz/60Hz
 光通量/Luminous Flux: 1200LM
 显色指数/CRI: Ra≥80
 色温/Color Temperature: 3000K/4000K/6000K

内箱尺寸/Box size: 145*145*65mm
 外箱尺寸/ Carton size: 600*450*345mm
 包装数/Qty/Ctn: 60PCS
 灯体材质/Material: 铝/Aluminum



Model: TH04F20C

灯具功率/Light Power: COB 20W
 输入电压/Input Voltage: AC180-240V 50Hz/60Hz
 光通量/Luminous Flux: 1600LM
 显色指数/CRI: Ra≥80
 色温/Color Temperature: 3000K/4000K/6000K

内箱尺寸/Box size: 165*165*70mm
 外箱尺寸/ Carton size: 680*345*370mm
 包装数/Qty/Ctn: 40PCS
 灯体材质/Material: 铝/Aluminum

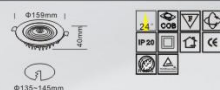

COB天花灯·晴朗系列



Model: TH01B03C

灯具功率/Light Power: COB 3W
 输入电压/Input Voltage: AC180-240V 50Hz/60Hz
 光通量/Luminous Flux: 240LM
 显色指数/CRI: Ra≥80
 色温/Color Temperature: 3000K/4000K/5500K

内箱尺寸/Box size: 95x95x60mm
 外箱尺寸/ Carton size: 495x300x260mm
 包装数/Qty/Ctn: 60PCS
 灯体材质/Material: 铝/Aluminum



Model: TH01B05C

灯具功率/Light Power: COB 5W
 输入电压/Input Voltage: AC220-240V 50Hz/60Hz
 光通量/Luminous Flux: 400LM
 显色指数/CRI: Ra≥80
 色温/Color Temperature: 3000K/4000K/5500K

内箱尺寸/Box size: 95x95x60mm
 外箱尺寸/ Carton size: 495x300x260mm
 包装数/Qty/Ctn: 60PCS
 灯体材质/Material: 铝/Aluminum



Model: TH02B07C

灯具功率/Light Power: COB 7W
 输入电压/Input Voltage: AC180-240V 50Hz/60Hz
 光通量/Luminous Flux: 560LM
 显色指数/CRI: Ra≥80
 色温/Color Temperature: 3000K/4000K/5500K

内箱尺寸/Box size: 120x120x60mm
 外箱尺寸/ Carton size: 620x255x320mm
 包装数/Qty/Ctn: 50PCS
 灯体材质/Material: 铝/Aluminum

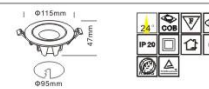

Model: TH02B10C

灯具功率/Light Power: COB 10W
 输入电压/Input Voltage: AC180-240V 50Hz/60Hz
 光通量/Luminous Flux: 800LM
 显色指数/CRI: Ra≥80
 色温/Color Temperature: 3000K/4000K/5500K

内箱尺寸/Box size: 120x120x60mm
 外箱尺寸/ Carton size: 600x305x320mm
 包装数/Qty/Ctn: 50PCS
 灯体材质/Material: 铝/Aluminum

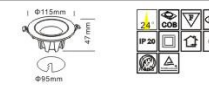

Model: TH03B15C

灯具功率/Light Power: COB 15W
 输入电压/Input Voltage: AC180-240V 50Hz/60Hz
 光通量/Luminous Flux: 1200LM
 显色指数/CRI: Ra≥80
 色温/Color Temperature: 3000K/4000K/5500K

内箱尺寸/Box size: 145x145x75mm
 外箱尺寸/ Carton size: 600x305x320mm
 包装数/Qty/Ctn: 32PCS
 灯体材质/Material: 铝/Aluminum

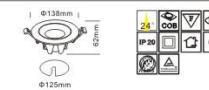



Model: RS-2046

灯具功率/Light Power: COB 15W
 输入电压/Input Voltage: AC180-240V 50Hz/60Hz
 光通量/Luminous Flux: 1200LM
 显色指数/CRI: Ra≥80
 色温/Color Temperature: 3000K/4000K/6000K

内箱尺寸/Box size: 125x125x100mm
 外箱尺寸/ Carton size: 645x265x320mm
 包装数/Qty/Ctn: 30PCS
 灯体材质/Material: 铝/Aluminum

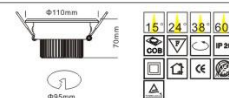

Model: RS-2047

灯具功率/Light Power: COB 20W
 输入电压/Input Voltage: AC180-240V 50Hz/60Hz
 光通量/Luminous Flux: 1600LM
 显色指数/CRI: Ra≥80
 色温/Color Temperature: 3000K/4000K/6000K

内箱尺寸/Box size: 145x145x100mm
 外箱尺寸/ Carton size: 745x305x320mm
 包装数/Qty/Ctn: 30PCS
 灯体材质/Material: 铝/Aluminum

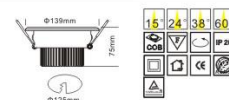

Model: RS-2048

灯具功率/Light Power: COB 30W
 输入电压/Input Voltage: AC180-240V 50Hz/60Hz
 光通量/Luminous Flux: 2400LM
 显色指数/CRI: Ra≥80
 色温/Color Temperature: 3000K/4000K/6000K

内箱尺寸/Box size: 180x180x110mm
 外箱尺寸/ Carton size: 560x375x350mm
 包装数/Qty/Ctn: 18PCS
 灯体材质/Material: 铝/Aluminum

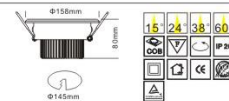

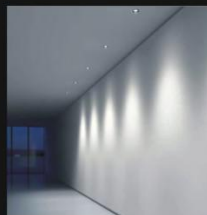

● 产品特点 Characteristic:

- 灯体采用优质高铝材，经典平面小斜边款式，大气时尚，欧洲级工艺水准，世界的品质标准；
- 采用优质LED光源，高端封装工艺，顶级品质，光色稳定，配以专业的小角度光学透镜，防眩光设计，发光均匀，无暗影，亮度高，光斑完美；
- 采用恒流驱动，质量更稳定，使用寿命更长，光线无频闪，保护眼视力；

● The lamp body is made of aerospace Precision aluminum, the atmosphere among the European level, process level, world class quality standards;

● Adopt LED light source, the high-end packaging technology, top quality, color stability, with small angle professional optical lens, anti-glare design, even lighting, no shadow, high brightness, perfect spot;

● Using constant current drive, more stable quality, long service life, light, no flicker, protect the eyes

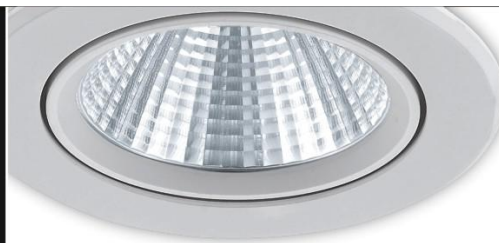

Model: TH05D03C

灯具功率/Light Power: COB 3W
输入电压/Input Voltage: AC 180-240V 50Hz/60Hz
光通量/Luminous Flux: 240LM
显色指数/CRI: Ra≥80
色温/Color Temperature: 3000K/4000K/5500K

内箱尺寸/Box size: 85x85x70mm
外箱尺寸/ Carton size: 445x270x300mm
包装数/Qty/Ctn: 60PCS
灯体材质/Material: 铝/Aluminum

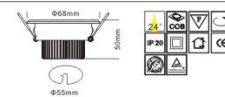

Model: TH01A05C

灯具功率/Light Power: COB 5W
输入电压/Input Voltage: AC 180-240V 50Hz/60Hz
光通量/Luminous Flux: 400LM
显色指数/CRI: Ra≥80
色温/Color Temperature: 3000K/4000K/5500K

内箱尺寸/Box size: 95x95x60mm
外箱尺寸/ Carton size: 445x300x360mm
包装数/Qty/Ctn: 60PCS
灯体材质/Material: 铝/Aluminum

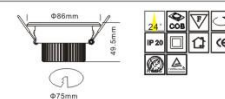

Model: TH02A10C

灯具功率/Light Power: COB 10W
输入电压/Input Voltage: AC 180-240V 50Hz/60Hz
光通量/Luminous Flux: 800LM
显色指数/CRI: Ra≥80
色温/Color Temperature: 3000K/4000K/5500K

内箱尺寸/Box size: 120x120x85mm
外箱尺寸/ Carton size: 500x255x360mm
包装数/Qty/Ctn: 32PCS
灯体材质/Material: 铝/Aluminum

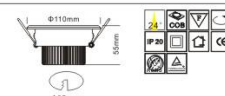

Model: TH02A15C

灯具功率/Light Power: COB 15W
输入电压/Input Voltage: AC 180-240V 50Hz/60Hz
光通量/Luminous Flux: 1200LM
显色指数/CRI: Ra≥80
色温/Color Temperature: 3000K/4000K/5500K

内箱尺寸/Box size: 120x120x85mm
外箱尺寸/ Carton size: 500x255x360mm
包装数/Qty/Ctn: 32PCS
灯体材质/Material: 铝/Aluminum

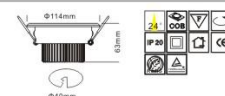

Model: TH03A20C

灯具功率/Light Power: COB 20W
输入电压/Input Voltage: AC 180-240V 50Hz/60Hz
光通量/Luminous Flux: 1600LM
显色指数/CRI: Ra≥80
色温/Color Temperature: 3000K/4000K/5500K

内箱尺寸/Box size: 145x145x85mm
外箱尺寸/ Carton size: 600x305x360mm
包装数/Qty/Ctn: 32PCS
灯体材质/Material: 铝/Aluminum

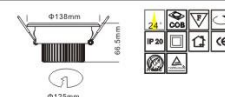

Model: TH04A30C

灯具功率/Light Power: COB 30W
输入电压/Input Voltage: AC 180-240V 50Hz/60Hz
光通量/Luminous Flux: 2400LM
显色指数/CRI: Ra≥80
色温/Color Temperature: 3000K/4000K/5500K

内箱尺寸/Box size: 170x170x95mm
外箱尺寸/ Carton size: 530x355x305mm
包装数/Qty/Ctn: 18PCS
灯体材质/Material: 铝/Aluminum

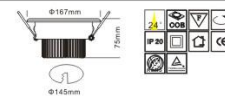

RONSE

LED Down light series



TD04M24C P 047



TD04K20C P 049



TD25C05S P 050



TD17A05A P 051



TD25H05S P 053



TD25H05C P 056



MUSIC DOWN LIGHT

两个一组，最大支持8组，共16个音响灯具连接使用
Two pcs as one group, maximum connection is eight groups

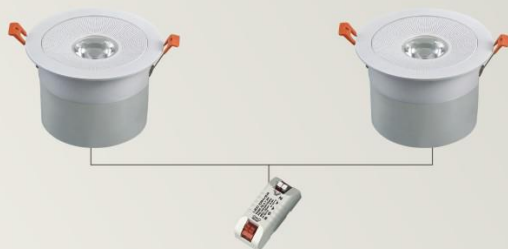

了哥音响筒灯系列



音响和灯光一举两得

轻松打造梦幻立体声,房间秒变影院
灯光和音乐影响我们的情绪和活动
Make your room being a private cinema



Model: TD04M24C

灯具功率/Light Power: COB 10W+音频5W(单灯)
输入电压/Input Voltage: AC180-240V 50Hz/60Hz
光通量/Luminous Flux: 1920LM
显色指数/CRI: Ra≥80
色温/Color Temperature: 3000K/4000K/6000K

内箱尺寸/Box size: 310x160x100mm(2个装)
外箱尺寸/ Carton size: 635x335x220mm
包装数/Qty/Ctn: 8PCS
灯体材质/Material: 铝/Aluminum

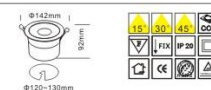

COB筒灯·明月系列



Model: TD04K20C

灯具功率/Light Power: COB 15W/20W
 输入电压/Input Voltage: AC180-240V 50Hz/60Hz
 光通量/Luminous Flux: 1350LM/1800LM
 显色指数/CRI: Ra≥80
 色温/Color Temperature: 3000K/4000K/6000K

内箱尺寸/Box size: 150x150x80mm
 外箱尺寸/ Carton size: 620x315x260mm
 包装数/Qty/Ctn: 30PCS
 灯体材质/Material: 铝/Aluminum



Model: TD06K30C

灯具功率/Light Power: COB 30W
 输入电压/Input Voltage: AC180-240V 50Hz/60Hz
 光通量/Luminous Flux: 2700LM
 显色指数/CRI: Ra≥80
 色温/Color Temperature: 3000K/4000K/6000K

内箱尺寸/Box size: 195x195x100mm
 外箱尺寸/ Carton size: 605x405x320mm
 包装数/Qty/Ctn: 18PCS
 灯体材质/Material: 铝/Aluminum

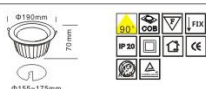

Model: TD08K40C

灯具功率/Light Power: COB 40W
 输入电压/Input Voltage: AC180-240V 50Hz/60Hz
 光通量/Luminous Flux: 3600LM
 显色指数/CRI: Ra≥80
 色温/Color Temperature: 3000K/4000K/6000K

内箱尺寸/Box size: 235x235x115mm
 外箱尺寸/ Carton size: 725x250x365mm
 包装数/Qty/Ctn: 9PCS
 灯体材质/Material: 铝/Aluminum

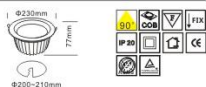

Model: TD08K60C

灯具功率/Light Power: COB 60W
 输入电压/Input Voltage: AC180-240V 50Hz/60Hz
 光通量/Luminous Flux: 5400LM
 显色指数/CRI: Ra≥80
 色温/Color Temperature: 3000K/4000K/6000K

内箱尺寸/Box size: 235x235x115mm
 外箱尺寸/ Carton size: 725x250x365mm
 包装数/Qty/Ctn: 9PCS
 灯体材质/Material: 铝/Aluminum

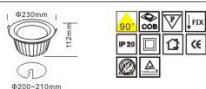

SMD筒灯·皓月系列



Model: TD25C05S

灯具功率/Light Power: SMD 5W
 输入电压/Input Voltage: AC180-240V 50Hz/60Hz
 光通量/Luminous Flux: 350LM
 显色指数/CRI: Ra≥80
 色温/Color Temperature: 3000K/4000K/6000K

内箱尺寸/Box size: 105x65x105mm(2个装)
 外箱尺寸/ Carton size: 545x345x230mm
 包装数/Qty/Ctn: 100PCS
 灯体材质/Material: 铝/Aluminum



Model: TD35C07S

灯具功率/Light Power: SMD 7W
 输入电压/Input Voltage: AC180-240V 50Hz/60Hz
 光通量/Luminous Flux: 490LM
 显色指数/CRI: Ra≥80
 色温/Color Temperature: 3000K/4000K/6000K

内箱尺寸/Box size: 125x40x125mm
 外箱尺寸/ Carton size: 520x420x270mm
 包装数/Qty/Ctn: 80PCS
 灯体材质/Material: 铝/Aluminum

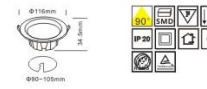

Model: TD04C12S

灯具功率/Light Power: SMD 12W
 输入电压/Input Voltage: AC180-240V 50Hz/60Hz
 光通量/Luminous Flux: 850LM
 显色指数/CRI: Ra≥80
 色温/Color Temperature: 3000K/4000K/6000K

内箱尺寸/Box size: 145x40x145mm
 外箱尺寸/ Carton size: 450x420x310mm
 包装数/Qty/Ctn: 60PCS
 灯体材质/Material: 铝/Aluminum

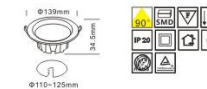

Model: TD06C18S

灯具功率/Light Power: SMD 18W
 输入电压/Input Voltage: AC180-240V 50Hz/60Hz
 光通量/Luminous Flux: 1200LM
 显色指数/CRI: Ra≥80
 色温/Color Temperature: 3000K/4000K/6000K

内箱尺寸/Box size: 180x45x180mm
 外箱尺寸/ Carton size: 470x375x380mm
 包装数/Qty/Ctn: 40PCS
 灯体材质/Material: 铝/Aluminum

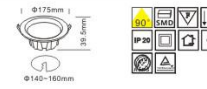

Model: TD08C25S

灯具功率/Light Power: SMD 25W
 输入电压/Input Voltage: AC180-240V 50Hz/60Hz
 光通量/Luminous Flux: 1750LM
 显色指数/CRI: Ra≥80
 色温/Color Temperature: 3000K/4000K/6000K

内箱尺寸/Box size: 230x50x230mm
 外箱尺寸/ Carton size: 620x475x250mm
 包装数/Qty/Ctn: 24PCS
 灯体材质/Material: 铝/Aluminum

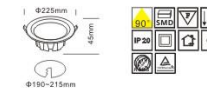

Model: TD08C30S

灯具功率/Light Power: SMD 30W
 输入电压/Input Voltage: AC180-240V 50Hz/60Hz
 光通量/Luminous Flux: 2100LM
 显色指数/CRI: Ra≥80
 色温/Color Temperature: 3000K/4000K/6000K

内箱尺寸/Box size: 230x50x230mm
 外箱尺寸/ Carton size: 620x475x250mm
 包装数/Qty/Ctn: 24PCS
 灯体材质/Material: 铝/Aluminum

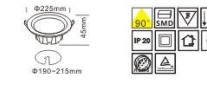

设计灵感
来源于优雅爵士帽



SMD筒灯·时代系列



Model: TD17A05A

灯具功率/Light Power: SMD 5W
输入电压/Input Voltage: AC180-240V 50Hz/60Hz
光通量/Luminous Flux: 400LM
显色指数/CRI: Ra≥80
色温/Color Temperature: 3000K/4000K/6000K

内箱尺寸/Box size: 105x45x105mm
外箱尺寸/Carton size: 545x290x230mm
包装数/Qty/Ctn: 60PCS
灯体材质/Material: 铁/Iron+PC



Model: TD17A07A

灯具功率/Light Power: SMD 7W
输入电压/Input Voltage: AC180-240V 50Hz/60Hz
光通量/Luminous Flux: 560LM
显色指数/CRI: Ra≥80
色温/Color Temperature: 3000K/4000K/6000K

内箱尺寸/Box size: 125x45x125mm
外箱尺寸/Carton size: 645x290x270mm
包装数/Qty/Ctn: 60PCS
灯体材质/Material: 铁/Iron+PC



Model: TD17A12A

灯具功率/Light Power: SMD 12W
输入电压/Input Voltage: AC180-240V 50Hz/60Hz
光通量/Luminous Flux: 960LM
显色指数/CRI: Ra≥80
色温/Color Temperature: 3000K/4000K/6000K

内箱尺寸/Box size: 152x50x152mm
外箱尺寸/Carton size: 630x270x325mm
包装数/Qty/Ctn: 40PCS
灯体材质/Material: 铁/Iron+PC



Model: TD17A18A

灯具功率/Light Power: SMD 18W
输入电压/Input Voltage: AC180-240V 50Hz/60Hz
光通量/Luminous Flux: 1440LM
显色指数/CRI: Ra≥80
色温/Color Temperature: 3000K/4000K/6000K

内箱尺寸/Box size: 185x55x185mm
外箱尺寸/Carton size: 575x295x390mm
包装数/Qty/Ctn: 30PCS
灯体材质/Material: 铁/Iron+PC





SMD筒灯·星际系列



Model: TD25H05S

灯具功率/Light Power: SMD 5W
 输入电压/Input Voltage: AC180-240V 50Hz/60Hz
 光通量/Luminous Flux: 350LM
 显色指数/CRI: Ra>=80
 色温/Color Temperature: 3000K/4000K/6000K

内箱尺寸/Box size: 102x60x102mm
 外箱尺寸/ Carton size: 530x321x260mm
 包装数/Qty/Ctn: 60PCS
 灯体材质/Material: 铝/Aluminum



Model: TD035H07S

灯具功率/Light Power: SMD 7W
 输入电压/Input Voltage: AC180-240V 50Hz/60Hz
 光通量/Luminous Flux: 490LM
 显色指数/CRI: Ra>=80
 色温/Color Temperature: 3000K/4000K/6000K

内箱尺寸/Box size: 120x60x120mm
 外箱尺寸/ Carton size: 620x255x320mm
 包装数/Qty/Ctn: 50PCS
 灯体材质/Material: 铝/Aluminum



Model: TD04H12S

灯具功率/Light Power: SMD 12W
 输入电压/Input Voltage: AC180-240V 50Hz/60Hz
 光通量/Luminous Flux: 850LM
 显色指数/CRI: Ra>=80
 色温/Color Temperature: 3000K/4000K/6000K

内箱尺寸/Box size: 141x70x141mm
 外箱尺寸/ Carton size: 584x297x320mm
 包装数/Qty/Ctn: 40PCS
 灯体材质/Material: 铝/Aluminum

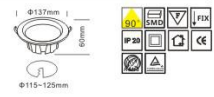

Model: TD06H18S

灯具功率/Light Power: SMD 18W
 输入电压/Input Voltage: AC180-240V 50Hz/60Hz
 光通量/Luminous Flux: 1200LM
 显色指数/CRI: Ra>=80
 色温/Color Temperature: 3000K/4000K/6000K

内箱尺寸/Box size: 190x80x190mm
 外箱尺寸/ Carton size: 590x395x420mm
 包装数/Qty/Ctn: 30PCS
 灯体材质/Material: 铝/Aluminum



Model: TD08H25S

灯具功率/Light Power: SMD 25W
 输入电压/Input Voltage: AC180-240V 50Hz/60Hz
 光通量/Luminous Flux: 1750LM
 显色指数/CRI: Ra>=80
 色温/Color Temperature: 3000K/4000K/6000K

内箱尺寸/Box size: 234x90x234mm
 外箱尺寸/ Carton size: 722x483x380mm
 包装数/Qty/Ctn: 24PCS
 灯体材质/Material: 铝/Aluminum

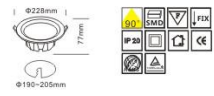

Model: TD08H30S

灯具功率/Light Power: SMD 30W
 输入电压/Input Voltage: AC180-240V 50Hz/60Hz
 光通量/Luminous Flux: 2100LM
 显色指数/CRI: Ra>=80
 色温/Color Temperature: 3000K/4000K/6000K

内箱尺寸/Box size: 234x90x234mm
 外箱尺寸/ Carton size: 722x483x380mm
 包装数/Qty/Ctn: 24PCS
 灯体材质/Material: 铝/Aluminum



● 产品特点 Characteristic;

- 灯体采用优质铝材，大气时尚，欧洲级工艺水准，世界级的品质标准；
- 选用优质品牌小功率芯片，显色指数高，寿命更长，光衰更小，配以PMMA光学扩散板，光线柔和，节能表现优异；
- 采用恒流驱动，质量更稳定，使用寿命更长，光线无频闪，保护视力；
- The lamp body is made of Aerospace Precision aluminum, the atmosphere among the European level, process level, world class quality standards;
- Selection of imported brands of small power chip, high color rendering index, longer service life, light attenuation is smaller, with the diffusion plate, the optical PMMA soft light, energy-saving performance
- Using constant current drive, more stable quality, long service life, light, no flicker, protect the eyes

COB筒灯·星际系列



Model: TD25H05C

灯具功率/Light Power: COB 5W
 输入电压/Input Voltage: AC180-240V 50Hz/60Hz
 光通量/Luminous Flux: 350LM
 显色指数/CRI: Ra≥80
 色温/Color Temperature: 3000K/4000K/6000K

内箱尺寸/Box size: 102x60x102mm
 外箱尺寸/Carton size: 530x321x260mm
 包装数/Qty/Ctn: 60PCS
 灯体材质/Material: 铝/Aluminum

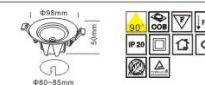

Model: TD35H07C

灯具功率/Light Power: COB 7W
 输入电压/Input Voltage: AC180-240V 50Hz/60Hz
 光通量/Luminous Flux: 490LM
 显色指数/CRI: Ra≥80
 色温/Color Temperature: 3000K/4000K/6000K

内箱尺寸/Box size: 120x60x120mm
 外箱尺寸/Carton size: 620x255x320mm
 包装数/Qty/Ctn: 50PCS
 灯体材质/Material: 铝/Aluminum

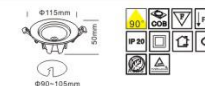

Model: TD04H12C

灯具功率/Light Power: COB 12W
 输入电压/Input Voltage: AC180-240V 50Hz/60Hz
 光通量/Luminous Flux: 850LM
 显色指数/CRI: Ra≥80
 色温/Color Temperature: 3000K/4000K/6000K

内箱尺寸/Box size: 141x70x141mm
 外箱尺寸/Carton size: 584x297x320mm
 包装数/Qty/Ctn: 40PCS
 灯体材质/Material: 铝/Aluminum

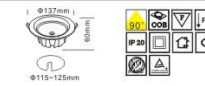

Model: TD06H20C

灯具功率/Light Power: COB 18W
 输入电压/Input Voltage: AC180-240V 50Hz/60Hz
 光通量/Luminous Flux: 1200LM
 显色指数/CRI: Ra≥80
 色温/Color Temperature: 3000K/4000K/6000K

内箱尺寸/Box size: 190x80x190mm
 外箱尺寸/Carton size: 590x395x420mm
 包装数/Qty/Ctn: 30PCS
 灯体材质/Material: 铝/Aluminum

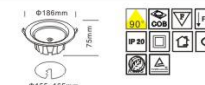

Model: TD08H25C

灯具功率/Light Power: COB 25W
 输入电压/Input Voltage: AC180-240V 50Hz/60Hz
 光通量/Luminous Flux: 1750LM
 显色指数/CRI: Ra≥80
 色温/Color Temperature: 3000K/4000K/6000K

内箱尺寸/Box size: 234x90x234mm
 外箱尺寸/Carton size: 722x483x380mm
 包装数/Qty/Ctn: 24PCS
 灯体材质/Material: 铝/Aluminum

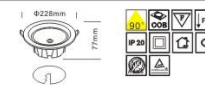

Model: TD08H30C

灯具功率/Light Power: COB 30W
 输入电压/Input Voltage: AC180-240V 50Hz/60Hz
 光通量/Luminous Flux: 2100LM
 显色指数/CRI: Ra≥80
 色温/Color Temperature: 3000K/4000K/6000K

内箱尺寸/Box size: 234x90x234mm
 外箱尺寸/Carton size: 722x483x380mm
 包装数/Qty/Ctn: 24PCS
 灯体材质/Material: 铝/Aluminum



RONSE

LED Spotlight series



WL18B12D P 059



WL18B12A P 059



RS-2117A P 059



WL18C15A P 060



WL18C30B P 060



WL01C07C P 060



WL18B12B P 061



WL18B12C P 061



WL18B24D P 061



WL18A10A P 062



黑色 Black 白色 White 金色 Gold



Model: WL18B12D

灯具功率/Light Power: COB 12W
输入电压/Input Voltage: AC180~240V 50Hz/60Hz
光通量/Luminous Flux: 960LM
显色指数/CRI: Ra≥80
色温/Color Temperature: 3000K/4000K/6000K

内箱尺寸/Box size: 160x90x65mm
外箱尺寸/ Carton size: 460x350x430mm
包装数/Qty/Ctn: 50PCS
灯体材质/Material: 铝/Aluminum

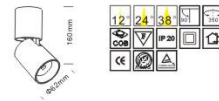

Model: WL18B12A

灯具功率/Light Power: COB 12W
输入电压/Input Voltage: AC180~240V 50Hz/60Hz
光通量/Luminous Flux: 960LM
显色指数/CRI: Ra≥80
色温/Color Temperature: 3000K/4000K/6000K

内箱尺寸/Box size: 124x76x100mm
外箱尺寸/ Carton size: 520x400x265mm
包装数/Qty/Ctn: 50PCS
灯体材质/Material: 铝/Aluminum

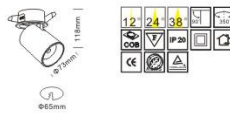

Model: RS-2117A

灯具功率/Light Power: COB 30/40W
输入电压/Input Voltage: AC180~240V 50Hz/60Hz
光通量/Luminous Flux: 2400LM/3200LM
显色指数/CRI: Ra≥80
色温/Color Temperature: 3000K/4000K/6000K

内箱尺寸/Box size: 150x150x235mm
外箱尺寸/ Carton size: 620x315x255mm
包装数/Qty/Ctn: 8PCS
灯体材质/Material: 铁+铝/Iron+Aluminum

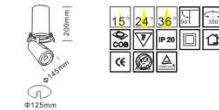

Model: WL18C15A

灯具功率/Light Power: COB 15W
输入电压/Input Voltage: AC180~240V 50Hz/60Hz
光通量/Luminous Flux: 1200LM
显色指数/CRI: Ra≥80
色温/Color Temperature: 3000K/4000K/6000K

内箱尺寸/Box size: 175x105x121.5mm
外箱尺寸/ Carton size: 545x365x263mm
包装数/Qty/Ctn: 20PCS
灯体材质/Material: 铝/Aluminum



Model: WL18C30B

灯具功率/Light Power: COB 2x15W
输入电压/Input Voltage: AC180~240V 50Hz/60Hz
光通量/Luminous Flux: 2400LM
显色指数/CRI: Ra≥80
色温/Color Temperature: 3000K/4000K/6000K

内箱尺寸/Box size: 305x105x121.5mm
外箱尺寸/ Carton size: 545x320x263mm
包装数/Qty/Ctn: 10PCS
灯体材质/Material: 铝/Aluminum

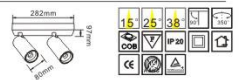

Model: WL01C07C

灯具功率/Light Power: COB 3x15W
输入电压/Input Voltage: AC180~240V 50Hz/60Hz
光通量/Luminous Flux: 3600LM
显色指数/CRI: Ra≥80
色温/Color Temperature: 3000K/4000K/6000K

内箱尺寸/Box size: 445x105x121.5mm
外箱尺寸/ Carton size: 465x330x263mm
包装数/Qty/Ctn: 6PCS
灯体材质/Material: 铝/Aluminum

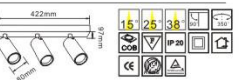



Model: WL18B12B

灯具功率/Light Power: COB 12W
 输入电压/Input Voltage: AC180~240V 50Hz/60Hz
 光通量/Luminous Flux: 960LM
 显色指数/CRI: Ra≥80
 色温/Color Temperature: 3000K/4000K/6000K

内箱尺寸/Box size: 115x115x120mm
 外箱尺寸/ Carton size: 620x250x470mm
 包装数/Qty/Ctn: 40PCS
 灯体材质/Material: 铝/Aluminum

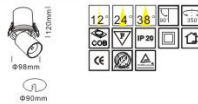

Model: WL18B12C

灯具功率/Light Power: COB 12W
 输入电压/Input Voltage: AC180~240V 50Hz/60Hz
 光通量/Luminous Flux: 960LM
 显色指数/CRI: Ra≥80
 色温/Color Temperature: 3000K/4000K/6000K

内箱尺寸/Box size: 115x115x120mm
 外箱尺寸/ Carton size: 620x250x470mm
 包装数/Qty/Ctn: 40PCS
 灯体材质/Material: 铝/Aluminum

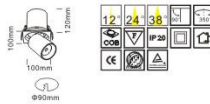

Model: WL18B24D

灯具功率/Light Power: COB 2x12W
 输入电压/Input Voltage: AC180~240V 50Hz/60Hz
 光通量/Luminous Flux: 1920LM
 显色指数/CRI: Ra≥80
 色温/Color Temperature: 3000K/4000K/6000K

内箱尺寸/Box size: 120x120x210mm
 外箱尺寸/ Carton size: 650x220x250mm
 包装数/Qty/Ctn: 10PCS
 灯体材质/Material: 铝/Aluminum

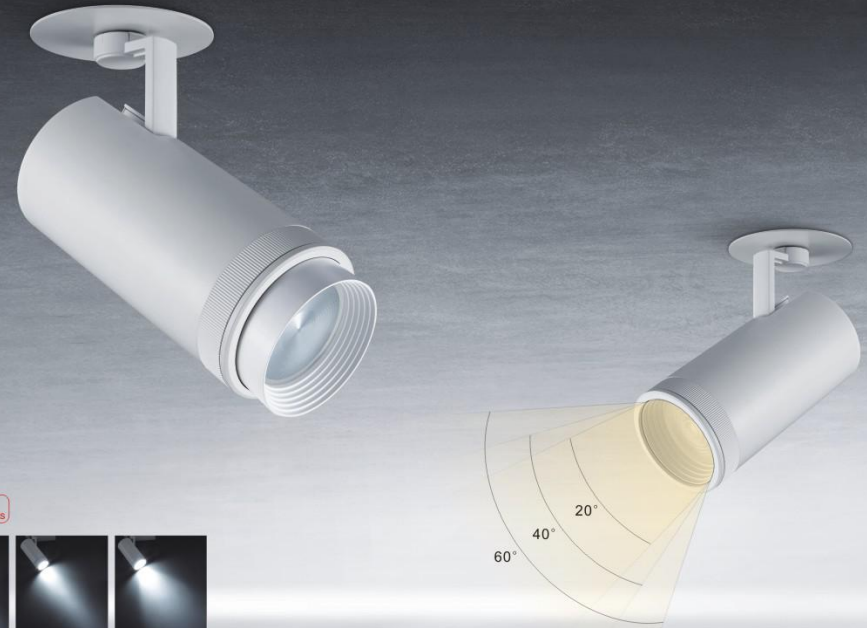
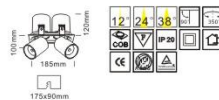

专利产品
Patented products



Model: WL18A10A

灯具功率/Light Power: COB 10W
 输入电压/Input Voltage: AC180~240V 50Hz/60Hz
 光通量/Luminous Flux: 800LM
 显色指数/CRI: Ra≥80
 色温/Color Temperature: 3000K/4000K/6000K

内箱尺寸/Box size: 100x100x265mm
 外箱尺寸/ Carton size: 625x420x285mm
 包装数/Qty/Ctn: 24PCS
 灯体材质/Material: 铝/Aluminum



Model: WL18A20B

灯具功率/Light Power: COB 20W
 输入电压/Input Voltage: AC180~240V 50Hz/60Hz
 光通量/Luminous Flux: 1600LM
 显色指数/CRI: Ra≥80
 色温/Color Temperature: 3000K/4000K/6000K

内箱尺寸/Box size: 105x105x270mm
 外箱尺寸/ Carton size: 545x440x290mm
 包装数/Qty/Ctn: 20PCS
 灯体材质/Material: 铝/Aluminum



Model: WL18A30C

灯具功率/Light Power: COB 30W/40W
 输入电压/Input Voltage: AC180~240V 50Hz/60Hz
 光通量/Luminous Flux: 2400LM/3200LM
 显色指数/CRI: Ra≥80
 色温/Color Temperature: 3000K/4000K/6000K

内箱尺寸/Box size: 125x125x300mm
 外箱尺寸/ Carton size: 520x265x320mm
 包装数/Qty/Ctn: 8PCS
 灯体材质/Material: 铝/Aluminum



RONSE

LED Trunk lamp series



RS-T610C P 065



RS-2120-1 P 066



RS-2120-2 P 066



RS-T107C P 068



Model: RS-T610C

灯具功率/Light Power: COB 10W
输入电压/Input Voltage: AC180-240V 50Hz/60Hz
光通量/Luminous Flux: 800LM
显色指数/CRI: Ra ≥ 80
色温/Color Temperature: 3000K/4000K/6000K

内箱尺寸/Box size: 95x95x95mm
外箱尺寸/ Carton size: 495x205x360mm
包装数/Qty/Ctn: 40PCS
灯体材质/Material: 铝/Aluminum



Model: RS-T620C

灯具功率/Light Power: COB 20W
输入电压/Input Voltage: AC180-240V 50Hz/60Hz
光通量/Luminous Flux: 1600LM
显色指数/CRI: Ra ≥ 80
色温/Color Temperature: 3000K/4000K/6000K

内箱尺寸/Box size: 110x110x95mm
外箱尺寸/ Carton size: 455x345x305mm
包装数/Qty/Ctn: 36PCS
灯体材质/Material: 铝/Aluminum



Model: RS-T630C

灯具功率/Light Power: COB 30W
输入电压/Input Voltage: AC180-240V 50Hz/60Hz
光通量/Luminous Flux: 2400LM
显色指数/CRI: Ra ≥ 80
色温/Color Temperature: 3000K/4000K/6000K

内箱尺寸/Box size: 145x145x130mm
外箱尺寸/ Carton size: 450x305x410mm
包装数/Qty/Ctn: 18PCS
灯体材质/Material: 铝/Aluminum



Model: RS-T640C

灯具功率/Light Power: COB 40W
输入电压/Input Voltage: AC180-240V 50Hz/60Hz
光通量/Luminous Flux: 3200LM
显色指数/CRI: Ra ≥ 80
色温/Color Temperature: 3000K/4000K/6000K

内箱尺寸/Box size: 165x165x160mm
外箱尺寸/ Carton size: 510x345x500mm
包装数/Qty/Ctn: 18PCS
灯体材质/Material: 铝/Aluminum

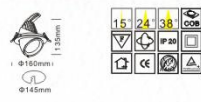

Model: RS-2120-1

灯具功率/Light Power: COB 20W
输入电压/Input Voltage: AC180-240V 50Hz/60Hz
光通量/Luminous Flux: 1600LM
显色指数/CRI: Ra ≥ 80
色温/Color Temperature: 3000K/4000K/6000K

内箱尺寸/Box size: 140x140x155mm
外箱尺寸/ Carton size: 580x300x330mm
包装数/Qty/Ctn: 16PCS
灯体材质/Material: 铝/Aluminum



Model: RS-2120-2

灯具功率/Light Power: COB 2x20W
输入电压/Input Voltage: AC180-240V 50Hz/60Hz
光通量/Luminous Flux: 3200LM
显色指数/CRI: Ra ≥ 80
色温/Color Temperature: 3000K/4000K/6000K

内箱尺寸/Box size: 230x140x155mm
外箱尺寸/ Carton size: 580x245x330mm
包装数/Qty/Ctn: 8PCS
灯体材质/Material: 铝/Aluminum



Model: RS-2130-1

灯具功率/Light Power: COB 30W
输入电压/Input Voltage: AC180-240V 50Hz/60Hz
光通量/Luminous Flux: 2400LM
显色指数/CRI: Ra ≥ 80
色温/Color Temperature: 3000K/4000K/6000K

内箱尺寸/Box size: 185x185x195mm
外箱尺寸/ Carton size: 575x390x410mm
包装数/Qty/Ctn: 12PCS
灯体材质/Material: 铝/Aluminum



Model: RS-2130-2

灯具功率/Light Power: COB 2x30W
输入电压/Input Voltage: AC180-240V 50Hz/60Hz
光通量/Luminous Flux: 4800LM
显色指数/CRI: Ra ≥ 80
色温/Color Temperature: 3000K/4000K/6000K

内箱尺寸/Box size: 305x185x195mm
外箱尺寸/ Carton size: 575x320x410mm
包装数/Qty/Ctn: 6PCS
灯体材质/Material: 铝/Aluminum



Model: RS-2140-1

灯具功率/Light Power: COB 40W
输入电压/Input Voltage: AC180-240V 50Hz/60Hz
光通量/Luminous Flux: 3200LM
显色指数/CRI: Ra ≥ 80
色温/Color Temperature: 3000K/4000K/6000K

内箱尺寸/Box size: 195x195x195mm
外箱尺寸/ Carton size: 600x405x410mm
包装数/Qty/Ctn: 12PCS
灯体材质/Material: 铝/Aluminum



Model: RS-2140-2

灯具功率/Light Power: COB 2x40W
输入电压/Input Voltage: AC180-240V 50Hz/60Hz
光通量/Luminous Flux: 6400LM
显色指数/CRI: Ra ≥ 80
色温/Color Temperature: 3000K/4000K/6000K

内箱尺寸/Box size: 350x195x195mm
外箱尺寸/ Carton size: 600x365x410mm
包装数/Qty/Ctn: 6PCS
灯体材质/Material: 铝/Aluminum





Model: RS-T107C

灯具功率/Light Power: COB 7W
 输入电压/Input Voltage: AC180~240V 50Hz/60Hz
 光通量/Luminous Flux: 560LM
 显色指数/CRI: Ra≥80
 色温/Color Temperature: 3000K/4000K/6000K

内箱尺寸/Box size: 85x85x75mm
 外箱尺寸/Carton size: 445x445x320mm
 包装数/Qty/Ctn: 100PCS
 灯体材质/Material: 铝/Aluminum



Model: RS-T210C

灯具功率/Light Power: COB 10W
 输入电压/Input Voltage: AC180~240V 50Hz/60Hz
 光通量/Luminous Flux: 800LM
 显色指数/CRI: Ra≥80
 色温/Color Temperature: 3000K/4000K/6000K

内箱尺寸/Box size: 120x120x115mm
 外箱尺寸/Carton size: 500x375x365mm
 包装数/Qty/Ctn: 36PCS
 灯体材质/Material: 铝/Aluminum



Model: RS-T320C

灯具功率/Light Power: COB 20W
 输入电压/Input Voltage: AC180~240V 50Hz/60Hz
 光通量/Luminous Flux: 1600LM
 显色指数/CRI: Ra≥80
 色温/Color Temperature: 3000K/4000K/6000K

内箱尺寸/Box size: 130x130x104mm
 外箱尺寸/Carton size: 540x405x330mm
 包装数/Qty/Ctn: 36PCS
 灯体材质/Material: 铝/Aluminum



Model: RS-T430C

灯具功率/Light Power: COB 30W
 输入电压/Input Voltage: AC180~240V 50Hz/60Hz
 光通量/Luminous Flux: 2400LM
 显色指数/CRI: Ra≥80
 色温/Color Temperature: 3000K/4000K/6000K

内箱尺寸/Box size: 160x160x130.5mm
 外箱尺寸/Carton size: 500x335x280mm
 包装数/Qty/Ctn: 12PCS
 灯体材质/Material: 铝/Aluminum



Model: RS-T540C

灯具功率/Light Power: COB 40W
 输入电压/Input Voltage: AC180~240V 50Hz/60Hz
 光通量/Luminous Flux: 3200LM
 显色指数/CRI: Ra≥80
 色温/Color Temperature: 3000K/4000K/6000K

内箱尺寸/Box size: 195x195x170mm
 外箱尺寸/Carton size: 605x405x360mm
 包装数/Qty/Ctn: 12PCS
 灯体材质/Material: 铝/Aluminum

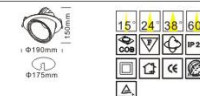

RONSE

LED Grille light series



RS-2114G-1 P 059



RS-2114G-2 P 059



RS-2114F-1 P 059



RS-2114F-2 P 060



RS-2106-1(C) P 060



RS-2106-2(C) P 060



RS-2106-3(C) P 060



RS-2112-1(C) P 061



RS-2112-2(C) P 061



RS-2112-3(C) P 061



RS-2115C P 062



Model: RS-2114G-1

灯具功率/Light Power: COB 20W/30W
输入电压/Input Voltage: AC180~240V 50Hz/60Hz
光通量/Luminous Flux: 1800LM/2700LM
显色指数/CRI: Ra≥80
色温/Color Temperature: 3000K/4000K/6000K

内箱尺寸/Box size: 195x185x90mm
外箱尺寸/Carton size: 575x405x380mm
包装数/Qty/Ctn: 18PCS
灯体材质/Material: 铝/ Aluminum

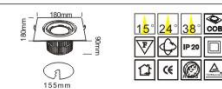

Model: RS-2114G-2

灯具功率/Light Power: COB 2x20W/30W
输入电压/Input Voltage: AC180~240V 50Hz/60Hz
光通量/Luminous Flux: 2x1800LM/2400LM
显色指数/CRI: Ra≥80
色温/Color Temperature: 3000K/4000K/6000K

内箱尺寸/Box size: 360x195x90mm
外箱尺寸/Carton size: 605x375x390mm
包装数/Qty/Ctn: 9PCS
灯体材质/Material: 铝/ Aluminum

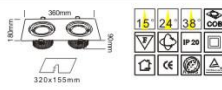

Model: RS-2114F-1

灯具功率/Light Power: COB 20W/30W
输入电压/Input Voltage: AC180~240V 50Hz/60Hz
光通量/Luminous Flux: 1800LM/2700LM
显色指数/CRI: Ra≥80
色温/Color Temperature: 3000K/4000K/6000K

内箱尺寸/Box size: 195x185x90mm
外箱尺寸/Carton size: 575x405x380mm
包装数/Qty/Ctn: 18PCS
灯体材质/Material: 铝/ Aluminum

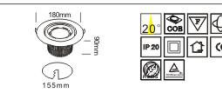

Model: RS-2114F-2

灯具功率/Light Power: COB 2x20W/30W
输入电压/Input Voltage: AC180~240V 50Hz/60Hz
光通量/Luminous Flux: 2x1800LM/2400LM
显色指数/CRI: Ra≥80
色温/Color Temperature: 3000K/4000K/6000K

内箱尺寸/Box size: 360x195x90mm
外箱尺寸/Carton size: 605x375x390mm
包装数/Qty/Ctn: 9PCS
灯体材质/Material: 铝/ Aluminum





Model: RS-2106-1(C)

灯具功率/Light Power: COB 10W
输入电压/Input Voltage: AC180-240V 50Hz/60Hz
光通量/Luminous Flux: 800LM
显色指数/CRI: Ra≥80
色温/Color Temperature: 3000K/4000K/6000K

内箱尺寸/Box size: 270x180x170mm
外箱尺寸/ Carton size: 620x375x360mm
包装数/Qty/Ctn: 12PCS
灯体材质/Material: 铁+铝/ Iron+Aluminum

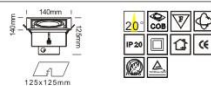

Model: RS-2106-2(C)

灯具功率/Light Power: COB 2x10W
输入电压/Input Voltage: AC180-240V 50Hz/60Hz
光通量/Luminous Flux: 1600LM
显色指数/CRI: Ra≥80
色温/Color Temperature: 3000K/4000K/6000K

内箱尺寸/Box size: 320x180x170mm
外箱尺寸/ Carton size: 660x375x360mm
包装数/Qty/Ctn: 8PCS
灯体材质/Material: 铁+铝/ Iron+Aluminum



Model: RS-2106-3(C)

灯具功率/Light Power: COB 3x10W
输入电压/Input Voltage: AC180-240V 50Hz/60Hz
光通量/Luminous Flux: 2400LM
显色指数/CRI: Ra≥80
色温/Color Temperature: 3000K/4000K/6000K

内箱尺寸/Box size: 405x230x170mm
外箱尺寸/ Carton size: 830x380x360mm
包装数/Qty/Ctn: 8PCS
灯体材质/Material: 铁+铝/ Iron+Aluminum



Model: RS-2108-1(C)

灯具功率/Light Power: COB 20W
输入电压/Input Voltage: AC180-240V 50Hz/60Hz
光通量/Luminous Flux: 1600LM
显色指数/CRI: Ra≥80
色温/Color Temperature: 3000K/4000K/6000K

内箱尺寸/Box size: 230x230x170mm
外箱尺寸/ Carton size: 710x475x360mm
包装数/Qty/Ctn: 12PCS
灯体材质/Material: 铁+铝/ Iron+Aluminum

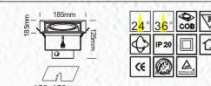

Model: RS-2108-2(C)

灯具功率/Light Power: COB 2x20W
输入电压/Input Voltage: AC180-240V 50Hz/60Hz
光通量/Luminous Flux: 3200LM
显色指数/CRI: Ra≥80
色温/Color Temperature: 3000K/4000K/6000K

内箱尺寸/Box size: 400x230x170mm
外箱尺寸/ Carton size: 820x475x360mm
包装数/Qty/Ctn: 8PCS
灯体材质/Material: 铁+铝/ Iron+Aluminum

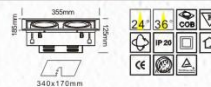

Model: RS-2108-3(C)

灯具功率/Light Power: COB 3x20W
输入电压/Input Voltage: AC180-240V 50Hz/60Hz
光通量/Luminous Flux: 4800LM
显色指数/CRI: Ra≥80
色温/Color Temperature: 3000K/4000K/6000K

内箱尺寸/Box size: 530x230x170mm
外箱尺寸/ Carton size: 550x465x360mm
包装数/Qty/Ctn: 6PCS
灯体材质/Material: 铁+铝/ Iron+Aluminum

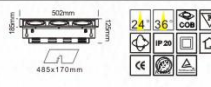

COB 格栅灯, 以对光学为设计理念, 从光应用的角度, 糅合现代LED照明的基本元素, 全新演绎商业环境的赢利之光, 为您带来高质量的生活与工作空间。适用于各类型公共场所、商场、汽车展厅、品牌专卖店、连锁店、百货公司、超市、博物馆办公大楼等重点、局部照明场所。

COB grille lamp, according to the optical design and from the light application, the basic elements of modern blend of LED lighting, a new interpretation of the business environment profit light, bring high-quality living and working space for you. Applicable to all types of public places, shops, showrooms, brand stores, chain stores, department stores, supermarkets, office building, Museum of key local lighting places.



Model: RS-2112-1(C)

	<p>灯具功率/Light Power: COB 7/10W 输入电压/Input Voltage: AC180~240V 50Hz/60Hz 光通量/Luminous Flux: 560/800LM 显色指数/CRI: Ra≥80 色温/Color Temperature: 3000K/4000K/6000K</p>	<p>内箱尺寸/Box size: 162x145x110mm 外箱尺寸/ Carton size: 665x305x460mm 包装数/Qty/Ctn: 32PCS 灯体材质/Material: 铝/Aluminum</p>		
--	--	--	--	---

Model: RS-2112-2(C)

	<p>灯具功率/Light Power: COB 2x7/10W 输入电压/Input Voltage: AC180~240V 50Hz/60Hz 光通量/Luminous Flux: 1120/1600LM 显色指数/CRI: Ra≥80 色温/Color Temperature: 3000K/4000K/6000K</p>	<p>内箱尺寸/Box size: 265x145x110mm 外箱尺寸/ Carton size: 810x315x350mm 包装数/Qty/Ctn: 18PCS 灯体材质/Material: 铝/Aluminum</p>		
---	--	--	---	--

Model: RS-2112-3(C)

	<p>灯具功率/Light Power: COB 3x7/10W 输入电压/Input Voltage: AC180~240V 50Hz/60Hz 光通量/Luminous Flux: 1680/2400LM 显色指数/CRI: Ra≥80 色温/Color Temperature: 3000K/4000K/6000K</p>	<p>内箱尺寸/Box size: 355x150x105mm 外箱尺寸/ Carton size: 725x315x335mm 包装数/Qty/Ctn: 12PCS 灯体材质/Material: 铝/Aluminum</p>		
---	--	--	---	--

Model: RS-2113-1(C)

	<p>灯具功率/Light Power: COB 10/15W 输入电压/Input Voltage: AC180~240V 50Hz/60Hz 光通量/Luminous Flux: 800/1200LM 显色指数/CRI: Ra≥80 色温/Color Temperature: 3000K/4000K/6000K</p>	<p>内箱尺寸/Box size: 190x175x105mm 外箱尺寸/ Carton size: 400x365x335mm 包装数/Qty/Ctn: 12PCS 灯体材质/Material: 铝/Aluminum</p>		
--	--	--	--	--

Model: RS-2113-2(C)

	<p>灯具功率/Light Power: COB 2x10/15W 输入电压/Input Voltage: AC180~240V 50Hz/60Hz 光通量/Luminous Flux: 1600/2400LM 显色指数/CRI: Ra≥80 色温/Color Temperature: 3000K/4000K/6000K</p>	<p>内箱尺寸/Box size: 330x180x110mm 外箱尺寸/ Carton size: 560x345x350mm 包装数/Qty/Ctn: 9PCS 灯体材质/Material: 铝/Aluminum</p>		
---	---	---	---	---

Model: RS-2113-3(C)

	<p>灯具功率/Light Power: COB 3x10/15W 输入电压/Input Voltage: AC180~240V 50Hz/60Hz 光通量/Luminous Flux: 2400/3600LM 显色指数/CRI: Ra≥80 色温/Color Temperature: 3000K/4000K/6000K</p>	<p>内箱尺寸/Box size: 410x180x110mm 外箱尺寸/ Carton size: 425x375x350mm 包装数/Qty/Ctn: 6PCS 灯体材质/Material: 铝/Aluminum</p>		
---	---	---	---	---



Model: RS-2114-1(C)

灯具功率/Light Power: COB 20W
输入电压/Input Voltage: AC180~240V 50Hz/60Hz
光通量/Luminous Flux: 1600LM
显色指数/CRI: Ra≥80
色温/Color Temperature: 3000K/4000K/6000K

内箱尺寸/Box size: 225x225x115mm
外箱尺寸/ Carton size: 695x465x365mm
包装数/Qty/Ctn: 18PCS
灯体材质/Material: 铝/Aluminum

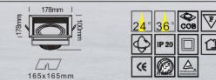

Model: RS-2114-2(C)

灯具功率/Light Power: COB 2x20W
输入电压/Input Voltage: AC180~240V 50Hz/60Hz
光通量/Luminous Flux: 3200LM
显色指数/CRI: Ra≥80
色温/Color Temperature: 3000K/4000K/6000K

内箱尺寸/Box size: 385x225x115mm
外箱尺寸/ Carton size: 695x400x365mm
包装数/Qty/Ctn: 9PCS
灯体材质/Material: 铝/Aluminum

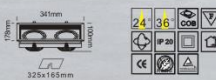

Model: RS-2114-3(C)

灯具功率/Light Power: COB 3x20W
输入电压/Input Voltage: AC180~240V 50Hz/60Hz
光通量/Luminous Flux: 4800LM
显色指数/CRI: Ra≥80
色温/Color Temperature: 3000K/4000K/6000K

内箱尺寸/Box size: 535x225x115mm
外箱尺寸/ Carton size: 695x465x365mm
包装数/Qty/Ctn: 6PCS
灯体材质/Material: 铝/Aluminum

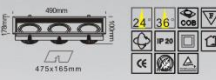

所有优秀的阵列都得益于照明的艺术。在经过近一个世纪的发展，创造了不同的照明解决方案，从而使观赏者在其中感受深刻。即使是良好的设计，如果照明产品应用不慎，珍贵的物品可能因为长时间处于过于明亮的灯光照射下而被破坏。我们为顾客与设计师指导并提供高效且安全、合适的照明设施。

All excellent exhibition have benefited from the art of lighting. After nearly a century of development, create different lighting solutions, so the viewer feeling in which profound. Even a good design, if you accidentally lighting product applications, valuable items may be damaged because a long time in an overly bright lights and. Its always the customer and the designer guidance and provide efficient and safe and appropriate lighting facilities.



Model: RS-2115C

灯具功率/Light Power: COB 45W
输入电压/Input Voltage: AC180~240V 50Hz/60Hz
光通量/Luminous Flux: 3600LM
显色指数/CRI: Ra≥80
色温/Color Temperature: 3000K/4000K/6000K

内箱尺寸/Box size: 280x205x135mm
外箱尺寸/ Carton size: 425x295x290mm
包装数/Qty/Ctn: 4PCS
灯体材质/Material: 铁+铝合金/iron+Aluminum

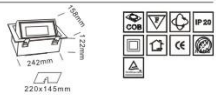

RONSE

LED Surface mounted downlight series



RS-2605A P 081



RS-2609 P 083



RS-2615 P 084



应用场所 Adopt space:
各类型公共场所、餐饮、商店、汽车展厅、品牌专卖店、百货公司、超市、博物馆、办公大厅等一切需要照明的场所
All types of public places, food market, shops, showrooms, brand stores, department stores, supermarkets, museums, office hall and all places of lighting required



Model: RS-2605A

灯具功率/Light Power: COB 15W
输入电压/Input Voltage: AC180-240V 50Hz/60Hz
光通量/Luminous Flux: 1200LM
显色指数/CRI: Ra>=80
色温/Color Temperature: 3000K/4000K/6000K

内箱尺寸/Box size: 80X80X170mm
外箱尺寸/ Carton size: 500X335X190mm
包装数/Qty/Ctn: 24PCS
灯体材质/Material: 铝/Aluminum



Model: RS-2605B

灯具功率/Light Power: COB 20W
输入电压/Input Voltage: AC180-240V 50Hz/60Hz
光通量/Luminous Flux: 1600LM
显色指数/CRI: Ra>=80
色温/Color Temperature: 3000K/4000K/6000K

内箱尺寸/Box size: 80x80x215mm
外箱尺寸/ Carton size: 500x335x235mm
包装数/Qty/Ctn: 24PCS
灯体材质/Material: 铝/Aluminum



Model: RS-2605C

灯具功率/Light Power: COB 30W
输入电压/Input Voltage: AC180-240V 50Hz/60Hz
光通量/Luminous Flux: 2400LM
显色指数/CRI: Ra>=80
色温/Color Temperature: 3000K/4000K/6000K

内箱尺寸/Box size: 80x80x275mm
外箱尺寸/ Carton size: 500x255x295mm
包装数/Qty/Ctn: 18PCS
灯体材质/Material: 铝/Aluminum





Model: RS-2609

灯具功率/Light Power: COB 10W
输入电压/Input Voltage: AC180-240V 50Hz/60Hz
光通量/Luminous Flux: 800LM
显色指数/CRI: Ra≥80
色温/Color Temperature: 3000K/4000K/6000K

内箱尺寸/Box size: 100x100x145mm
外箱尺寸/ Carton size: 520x315x310mm
包装数/Qty/Ctn: 30PCS
灯体材质/Material: 铝/Aluminum



Model: RS-2610

灯具功率/Light Power: COB 20W
输入电压/Input Voltage: AC180-240V 50Hz/60Hz
光通量/Luminous Flux: 1600LM
显色指数/CRI: Ra≥80
色温/Color Temperature: 3000K/4000K/6000K

内箱尺寸/Box size: 260x170x125mm
外箱尺寸/ Carton size: 520x355x395mm
包装数/Qty/Ctn: 24PCS
灯体材质/Material: 铝/Aluminum



Model: RS-2611

灯具功率/Light Power: COB 30W
输入电压/Input Voltage: AC180-240V 50Hz/60Hz
光通量/Luminous Flux: 2400LM
显色指数/CRI: Ra≥80
色温/Color Temperature: 3000K/4000K/6000K

内箱尺寸/Box size: 145x145x145mm
外箱尺寸/ Carton size: 455x305x310mm
包装数/Qty/Ctn: 12PCS
灯体材质/Material: 铝/Aluminum



应用场所 Adopt space:

各类型公共场所、餐饮、商店、汽车展厅、品牌专卖店、百货公司、超市、博物馆、办公大厅等一切需要照明的场所
All types of public places, food market, shops, showrooms, brand stores, department stores, supermarkets, museums, office hall and all places of lighting required



Model: RS-2615

灯具功率/Light Power: COB 15W
输入电压/Input Voltage: AC180-240V 50Hz/60Hz
光通量/Luminous Flux: 1200LM
显色指数/CRI: Ra≥80
色温/Color Temperature: 3000K/4000K/6000K

内箱尺寸/Box size: 115x115x125mm
外箱尺寸/ Carton size: 595x360x395mm
包装数/Qty/Ctn: 50PCS
灯体材质/Material: 铝/Aluminum



Model: RS-2616

灯具功率/Light Power: COB 20/25W
输入电压/Input Voltage: AC180-240V 50Hz/60Hz
光通量/Luminous Flux: 1600/2000LM
显色指数/CRI: Ra≥80
色温/Color Temperature: 3000K/4000K/6000K

内箱尺寸/Box size: 135x135x163mm
外箱尺寸/ Carton size: 555x285x505mm
包装数/Qty/Ctn: 24PCS
灯体材质/Material: 铝/Aluminum



Model: RS-2617

灯具功率/Light Power: COB 30W
输入电压/Input Voltage: AC180-240V 50Hz/60Hz
光通量/Luminous Flux: 2400LM
显色指数/CRI: Ra≥80
色温/Color Temperature: 3000K/4000K/6000K

内箱尺寸/Box size: 175x175x195mm
外箱尺寸/ Carton size: 545x365x410mm
包装数/Qty/Ctn: 12PCS
灯体材质/Material: 铝/Aluminum



Model: RS-2618

灯具功率/Light Power: COB 40W
输入电压/Input Voltage: AC180-240V 50Hz/60Hz
光通量/Luminous Flux: 3200LM
显色指数/CRI: Ra≥80
色温/Color Temperature: 3000K/4000K/6000K

内箱尺寸/Box size: 200x200x205mm
外箱尺寸/ Carton size: 620x415x430mm
包装数/Qty/Ctn: 12PCS
灯体材质/Material: 铝/Aluminum



RONSE

LED Hanging light series



RS-2350 P 087



RS-2340 P 087



RS-2305A P 088



RS-2318 P 089



RS-2302A P 090

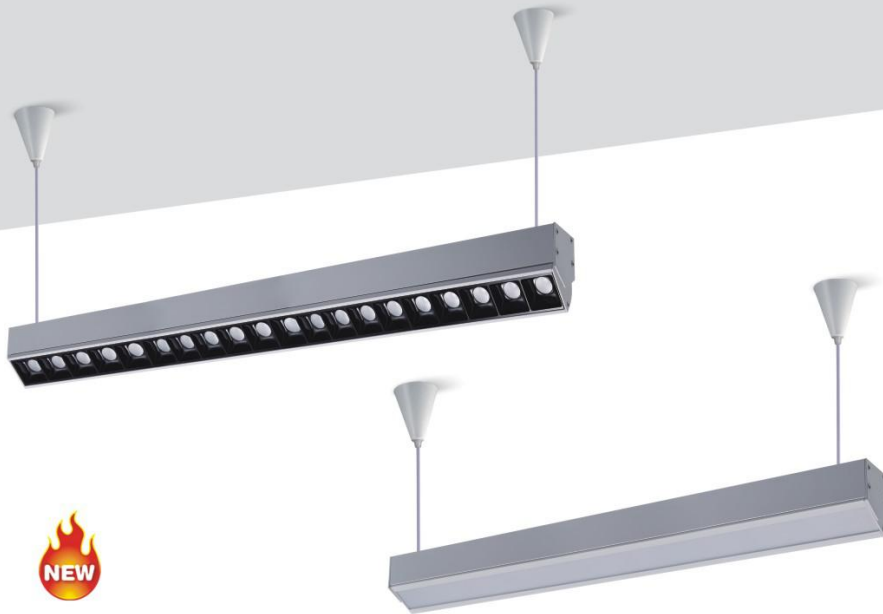

Model: RS-2350

灯具功率/Light Power: COB 50W
 输入电压/Input Voltage: AC180~240V 50Hz/60Hz
 光通量/Luminous Flux: 4000LM
 显色指数/CRI: Ra≥80
 色温/Color Temperature: 3000K/4000K/6000K

外箱尺寸/ Carton size: 1200x100x80mm
 包装数/Qty/Ctn: 1PCS
 灯体材质/Material: 铝/Aluminum

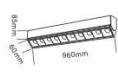

Model: RS-2340

灯具功率/Light Power: SMD 40W
 输入电压/Input Voltage: AC180~240V 50Hz/60Hz
 光通量/Luminous Flux: 3200LM
 显色指数/CRI: Ra≥80
 色温/Color Temperature: 3000K/4000K/6000K

外箱尺寸/ Carton size: 1000x90x80mm
 包装数/Qty/Ctn: 1PCS
 灯体材质/Material: 铝/Aluminum



Model: RS-2305A

灯具功率/Light Power: COB 15W
 输入电压/Input Voltage: AC180~240V 50Hz/60Hz
 光通量/Luminous Flux: 1200LM
 显色指数/CRI: Ra≥80
 色温/Color Temperature: 3000K/4000K/6000K

内箱尺寸/Box size: 155x80x170mm
 外箱尺寸/ Carton size: 500x325x190mm
 包装数/Qty/Ctn: 12PCS
 灯体材质/Material: 铝/Aluminum



Model: RS-2305B

灯具功率/Light Power: COB 20W
 输入电压/Input Voltage: AC180~240V 50Hz/60Hz
 光通量/Luminous Flux: 1600LM
 显色指数/CRI: Ra≥80
 色温/Color Temperature: 3000K/4000K/6000K

内箱尺寸/Box size: 155x80x215mm
 外箱尺寸/ Carton size: 500x325x235mm
 包装数/Qty/Ctn: 12PCS
 灯体材质/Material: 铝/Aluminum



Model: RS-2305C

灯具功率/Light Power: COB 30W
 输入电压/Input Voltage: AC180~240V 50Hz/60Hz
 光通量/Luminous Flux: 2400LM
 显色指数/CRI: Ra≥80
 色温/Color Temperature: 3000K/4000K/6000K

内箱尺寸/Box size: 155x80x275mm
 外箱尺寸/ Carton size: 500x255x295mm
 包装数/Qty/Ctn: 12PCS
 灯体材质/Material: 铝/Aluminum





COB吊灯用优质铝型材，其外观精美高档；采用高亮度、高显色性、色温一致性好的LED光源光线柔和舒适，安装简便，可直接代替传统光源灯具。

with high quality Aluminum Material ,pleasing appearance. Adopt high lumen, high rendering index and good consistency color temperature Light Source, soft light,no dazzle NO uv light,excellent heat dissipation, easy to install.can directly replace traditional Lamps.



Model: RS-2318

灯具功率/Light Power: COB 10W
输入电压/Input Voltage: AC180-240V 50Hz/60Hz
光通量/Luminous Flux: 800LM
显色指数/CRI: Ra≥80
色温/Color Temperature: 3000K/4000K/6000K

内箱尺寸/Box size: 235x102x102mm
外箱尺寸/ Carton size: 490x423x4280mm
包装数/Qty/Ctn: 30PCS
灯体材质/Material: 铝/Aluminum

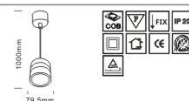

Model: RS-2319

灯具功率/Light Power: COB 20W
输入电压/Input Voltage: AC180-240V 50Hz/60Hz
光通量/Luminous Flux: 1600LM
显色指数/CRI: Ra≥80
色温/Color Temperature: 3000K/4000K/6000K

内箱尺寸/Box size: 270x135x135mm
外箱尺寸/ Carton size: 560x285x425mm
包装数/Qty/Ctn: 12PCS
灯体材质/Material: 铝/Aluminum



Model: RS-2320

灯具功率/Light Power: COB 30W
输入电压/Input Voltage: AC180-240V 50Hz/60Hz
光通量/Luminous Flux: 2400LM
显色指数/CRI: Ra≥80
色温/Color Temperature: 3000K/4000K/6000K

内箱尺寸/Box size: 240x145x145mm
外箱尺寸/ Carton size: 500x305x455mm
包装数/Qty/Ctn: 12PCS
灯体材质/Material: 铝/Aluminum

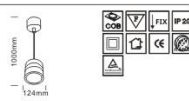

Model: RS-2302A

灯具功率/Light Power: COB 10W
输入电压/Input Voltage: AC180-240V 50Hz/60Hz
光通量/Luminous Flux: 800LM
显色指数/CRI: Ra≥80
色温/Color Temperature: 3000K/4000K/6000K

内箱尺寸/Box size: 245x195x195mm
外箱尺寸/ Carton size: 605x260x410mm
包装数/Qty/Ctn: 6PCS
灯体材质/Material: 铁+铝合金/iron+Aluminum



Model: RS-2301A

灯具功率/Light Power: COB 20W
输入电压/Input Voltage: AC180-240V 50Hz/60Hz
光通量/Luminous Flux: 1600LM
显色指数/CRI: Ra≥80
色温/Color Temperature: 3000K/4000K/6000K

内箱尺寸/Box size: 245x195x195mm
外箱尺寸/ Carton size: 605x260x410mm
包装数/Qty/Ctn: 6PCS
灯体材质/Material: 铁+铝合金/iron+Aluminum



Model: RS-RS-2303A

灯具功率/Light Power: COB 25W
输入电压/Input Voltage: AC180-240V 50Hz/60Hz
光通量/Luminous Flux: 2000LM
显色指数/CRI: Ra≥80
色温/Color Temperature: 3000K/4000K/6000K

内箱尺寸/Box size: 230x230x300mm
外箱尺寸/ Carton size: 710x475x320mm
包装数/Qty/Ctn: 6PCS
灯体材质/Material: 铁+铝合金/iron+Aluminum

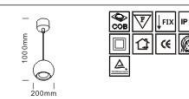

RONSE

LED Flood light series



FL01D010 P 093



FL01A010 P 095



FL03C030 P 098

简约风尚 国际典范
BONTRACTED FASHION,
THE INTERNATIONAL MODEL



• 产品特点:

灯具结构精简,具有良好的一体化散热功能。采用高强度压铸铝材料,面罩采用加厚钢化玻璃,抗冲击、耐摩擦。安装固定架可160°角范围内调节。防水级别为IP66,显色指数高达80。

The structure of the lamp body is simple and has good integrated heat dissipation function. High strength die-casting aluminum material is adopted. The mask is made of thickened tempered glass, which can resist impact and friction. Install the fixed frame can be adjusted within the scope of 160°. Angle. The waterproof level is IP66 and the color rendering index is up to 80.

SMD投光灯·阳光系列



Model: FL01D010

灯具功率/Light Power: SMD 10W
输入电压/Input Voltage: AC180-240V 50Hz/60Hz
光通量/Luminous Flux: 1000LM
显色指数/CRI: Ra>=80
色温/Color Temperature: 3000K/4000K/6000K

内箱尺寸/Box size: 115x30x110mm
外箱尺寸/ Carton size: 490x225x245mm
包装数/Qty/Ctn: 60PCS
灯体材质/Material: 压铸铝/Die Casting Aluminum



Model: FL02D030

灯具功率/Light Power: SMD 30W
输入电压/Input Voltage: AC180-240V 50Hz/60Hz
光通量/Luminous Flux: 3000LM
显色指数/CRI: Ra>=80
色温/Color Temperature: 3000K/4000K/6000K

内箱尺寸/Box size: 170x35x150mm
外箱尺寸/ Carton size: 560x195x325mm
包装数/Qty/Ctn: 30PCS
灯体材质/Material: 压铸铝/Die Casting Aluminum

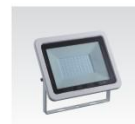

Model: FL03D050

灯具功率/Light Power: SMD 50W
输入电压/Input Voltage: AC180-240V 50Hz/60Hz
光通量/Luminous Flux: 5000LM
显色指数/CRI: Ra>=80
色温/Color Temperature: 3000K/4000K/6000K

内箱尺寸/Box size: 215x40x170mm
外箱尺寸/ Carton size: 435x235x365mm
包装数/Qty/Ctn: 20PCS
灯体材质/Material: 压铸铝/Die Casting Aluminum



Model: FL04D100

灯具功率/Light Power: SMD 100W
输入电压/Input Voltage: AC180-240V 50Hz/60Hz
光通量/Luminous Flux: 10000LM
显色指数/CRI: Ra>=80
色温/Color Temperature: 3000K/4000K/6000K

内箱尺寸/Box size: 280x40x220mm
外箱尺寸/ Carton size: 435x300x245mm
包装数/Qty/Ctn: 10PCS
灯体材质/Material: 压铸铝/Die Casting Aluminum

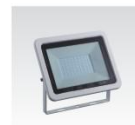

Model: FL05D200

灯具功率/Light Power: SMD 200W
输入电压/Input Voltage: AC180-240V 50Hz/60Hz
光通量/Luminous Flux: 20000LM
显色指数/CRI: Ra>=80
色温/Color Temperature: 3000K/4000K/6000K

内箱尺寸/Box size: 390x45x295mm
外箱尺寸/ Carton size: 410x205x320mm
包装数/Qty/Ctn: 4PCS
灯体材质/Material: 压铸铝/Die Casting Aluminum

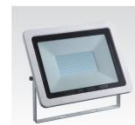
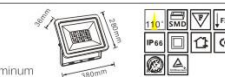

Model: FL06D300

灯具功率/Light Power: SMD 300W
输入电压/Input Voltage: AC180-240V 50Hz/60Hz
光通量/Luminous Flux: 30000LM
显色指数/CRI: Ra>=80
色温/Color Temperature: 3000K/4000K/6000K

内箱尺寸/Box size: 455x53x345mm
外箱尺寸/ Carton size: 475x240x370mm
包装数/Qty/Ctn: 4PCS
灯体材质/Material: 压铸铝/Die Casting Aluminum





• 产品特点:

灯体结构精简,具有良好的一体化散热功能。采用高强度压铸铝材料,面罩采用加厚钢化玻璃,抗冲击、耐摩擦。

安装固定架可160°角范围内调节。防水级别为IP66,显色指数高达80。

The structure of the lamp body is simple and has good integrated heat dissipation function. High strength die-casting aluminum material is adopted. The mask is made of thickened tempered glass, which can resist impact and friction. Install the fixed frame can be adjusted within the scope of 160°. Angle. The waterproof level is IP66 and the color rendering index is up to 80.

SMD投光灯·星梦系列



Model: FL01A010

灯具功率/Light Power: SMD 10W
输入电压/Input Voltage: AC180~240V 50Hz/60Hz
光通量/Luminous Flux: 800LM
显色指数/CRI: Ra≥80
色温/Color Temperature: 3000K/4000K/6000K

内箱尺寸/Box size: 140x45x130mm
外箱尺寸/Carton size: 440x245x280mm
包装数/Qty/Ctn: 30PCS
灯体材质/Material: 压铸铝/Die Casting Aluminum

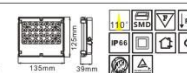

Model: FL02A020

灯具功率/Light Power: SMD 20W
输入电压/Input Voltage: AC180~240V 50Hz/60Hz
光通量/Luminous Flux: 1600LM
显色指数/CRI: Ra≥80
色温/Color Temperature: 3000K/4000K/6000K

内箱尺寸/Box size: 165x45x170mm
外箱尺寸/Carton size: 515x245x190mm
包装数/Qty/Ctn: 15PCS
灯体材质/Material: 压铸铝/Die Casting Aluminum

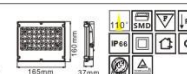

Model: FL03B030

灯具功率/Light Power: SMD 30W
输入电压/Input Voltage: AC180~240V 50Hz/60Hz
光通量/Luminous Flux: 2400LM
显色指数/CRI: Ra≥80
色温/Color Temperature: 3000K/4000K/6000K

内箱尺寸/Box size: 160x47x185mm
外箱尺寸/Carton size: 340x255x205mm
包装数/Qty/Ctn: 10PCS
灯体材质/Material: 压铸铝/Die Casting Aluminum

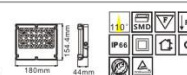

Model: FL04B050

灯具功率/Light Power: SMD 50W
输入电压/Input Voltage: AC180~240V 50Hz/60Hz
光通量/Luminous Flux: 4000LM
显色指数/CRI: Ra≥80
色温/Color Temperature: 3000K/4000K/6000K

内箱尺寸/Box size: 232x47x195mm
外箱尺寸/Carton size: 485x255x215mm
包装数/Qty/Ctn: 10PCS
灯体材质/Material: 压铸铝/Die Casting Aluminum

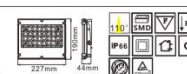

Model: FL05B100

灯具功率/Light Power: SMD 100W
输入电压/Input Voltage: AC180~240V 50Hz/60Hz
光通量/Luminous Flux: 8000LM
显色指数/CRI: Ra≥80
色温/Color Temperature: 3000K/4000K/6000K

内箱尺寸/Box size: 290x65x340mm
外箱尺寸/Carton size: 410x305x360mm
包装数/Qty/Ctn: 6PCS
灯体材质/Material: 压铸铝/Die Casting Aluminum

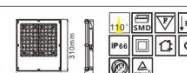

Model: FL06B150

灯具功率/Light Power: SMD 150W
输入电压/Input Voltage: AC180~240V 50Hz/60Hz
光通量/Luminous Flux: 12000LM
显色指数/CRI: Ra≥80
色温/Color Temperature: 3000K/4000K/6000K

内箱尺寸/Box size: 330x70x400mm
外箱尺寸/Carton size: 440x345x420mm
包装数/Qty/Ctn: 6PCS
灯体材质/Material: 压铸铝/Die Casting Aluminum

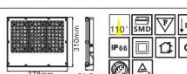

Model: FL07B200

灯具功率/Light Power: SMD 200W
输入电压/Input Voltage: AC180~240V 50Hz/60Hz
光通量/Luminous Flux: 16000LM
显色指数/CRI: Ra≥80
色温/Color Temperature: 3000K/4000K/6000K

内箱尺寸/Box size: 470x75x360mm
外箱尺寸/Carton size: 490x320x380mm
包装数/Qty/Ctn: 4PCS
灯体材质/Material: 压铸铝/Die Casting Aluminum

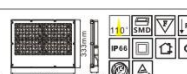

COB投光灯·星梦系列

应用场所/Application

楼宇内外装饰、舞台、展示厅、建筑群、广场等场所。
Building internal and external decoration places, stage, exhibition hall, the ancient buildings, Plaza etc.



Model: FL03C030

灯具功率/Light Power: COB 30W
输入电压/Input Voltage: AC180-240V 50Hz/60Hz
光通量/Luminous Flux: 2400LM
显色指数/CRI: Ra≥80
色温/Color Temperature: 3000K/4000K/6000K

内箱尺寸/Box size: 215x70x145mm
外箱尺寸/ Carton size: 455x300x235mm
包装数/Qty/Ctn: 12PCS
灯体材质/Material: 压铸铝/Die Casting Aluminum

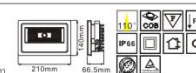

Model: FL04C050

灯具功率/Light Power: COB 50W
输入电压/Input Voltage: AC180-240V 50Hz/60Hz
光通量/Luminous Flux: 4000LM
显色指数/CRI: Ra≥80
色温/Color Temperature: 3000K/4000K/6000K

内箱尺寸/Box size: 250x80.5x197mm
外箱尺寸/ Carton size: 505x265x215mm
包装数/Qty/Ctn: 6PCS
灯体材质/Material: 压铸铝/Die Casting Aluminum

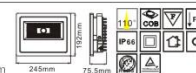

Model: FL05C100

灯具功率/Light Power: COB 100W
输入电压/Input Voltage: AC180-240V 50Hz/60Hz
光通量/Luminous Flux: 8000LM
显色指数/CRI: Ra≥80
色温/Color Temperature: 3000K/4000K/6000K

内箱尺寸/Box size: 270x111.5x310mm
外箱尺寸/ Carton size: 577.5x285x330mm
包装数/Qty/Ctn: 5PCS
灯体材质/Material: 压铸铝/Die Casting Aluminum

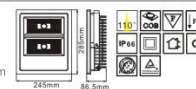

RONSE

LED High bay light series



Model: GK01C100

灯具功率/Light Power: SMD 100W
输入电压/Input Voltage: AC180-240V 50Hz/60Hz
光通量/Luminous Flux: 8000LM
显色指数/CRI: Ra>80

色温/Color Temperature: 3000K/4000K/6000K
外箱尺寸/Carton size: 355x355x155mm
包装数/Qty/Ctn: 1PCS
灯体材质/Material: 压铸铝/Die Casting Aluminum

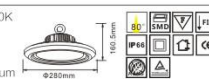

Model: GK01C150

灯具功率/Light Power: SMD 150W
输入电压/Input Voltage: AC180-240V 50Hz/60Hz
光通量/Luminous Flux: 12000LM
显色指数/CRI: Ra>80

色温/Color Temperature: 3000K/4000K/6000K
外箱尺寸/Carton size: 420x420x160mm
包装数/Qty/Ctn: 1PCS
灯体材质/Material: 压铸铝/Die Casting Aluminum

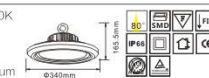

Model: GK02C200

灯具功率/Light Power: SMD 200W
输入电压/Input Voltage: AC180-240V 50Hz/60Hz
光通量/Luminous Flux: 16000LM
显色指数/CRI: Ra>80

色温/Color Temperature: 3000K/4000K/6000K
外箱尺寸/Carton size: 475x475x165mm
包装数/Qty/Ctn: 1PCS
灯体材质/Material: 压铸铝/Die Casting Aluminum



RONSE

LED Wall light series



B1010-1 P 103 B1010-2 P 103 B1011-1 P 104 B1012-1 P 104 B1006 P 104 B1008 P 105 WL01A12S P 105



WL01B12C P 105 WL01C07C P 106 WL01D07C P 106 WL01E06C P 106 B1009 P 106 B1013 P 106



Model: B1011-1

灯具功率/Light Power: SMD 9W
输入电压/Input Voltage: AC180-240V 50Hz/60Hz
光通量/Luminous Flux: 720LM
显色指数/CRI: Ra ≥ 80
色温/Color Temperature: 3000K
内箱尺寸/Box size: 205x205x40mm
外箱尺寸/ Carton size: 425x220x430mm
包装数/Qty/Ctn: 20PCS
灯体颜色/colour: 黑色/白色/金色/大理石
灯体材质/Material: 铝/Aluminum

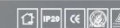

Model: B1012-1

灯具功率/Light Power: SMD 12W
输入电压/Input Voltage: AC180-240V 50Hz/60Hz
光通量/Luminous Flux: 960LM
显色指数/CRI: Ra ≥ 80
色温/Color Temperature: 3000K
内箱尺寸/Box size: 205x205x40mm
外箱尺寸/ Carton size: 425x220x430mm
包装数/Qty/Ctn: 20PCS
灯体颜色/colour: 黑色/白色/金色/大理石
灯体材质/Material: 铝/Aluminum

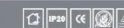

Model: B1011-2

灯具功率/Light Power: SMD 9W
输入电压/Input Voltage: AC180-240V 50Hz/60Hz
光通量/Luminous Flux: 720LM
显色指数/CRI: Ra ≥ 80
色温/Color Temperature: 3000K
内箱尺寸/Box size: 255x255x40mm
外箱尺寸/ Carton size: 530x220x530mm
包装数/Qty/Ctn: 20PCS
灯体颜色/colour: 黑色/白色/金色/大理石
灯体材质/Material: 铝/Aluminum



Model: B1012-2

灯具功率/Light Power: SMD 12W
输入电压/Input Voltage: AC180-240V 50Hz/60Hz
光通量/Luminous Flux: 960LM
显色指数/CRI: Ra ≥ 80
色温/Color Temperature: 3000K
内箱尺寸/Box size: 255x255x40mm
外箱尺寸/ Carton size: 530x220x530mm
包装数/Qty/Ctn: 20PCS
灯体颜色/colour: 黑色/白色/金色/大理石
灯体材质/Material: 铝/Aluminum



Model: B1011-3

灯具功率/Light Power: SMD 9W
输入电压/Input Voltage: AC180-240V 50Hz/60Hz
光通量/Luminous Flux: 720LM
显色指数/CRI: Ra ≥ 80
色温/Color Temperature: 3000K
内箱尺寸/Box size: 305x45x305mm
外箱尺寸/ Carton size: 620x250x630mm
包装数/Qty/Ctn: 20PCS
灯体颜色/colour: 黑色/白色/金色/大理石
灯体材质/Material: 铝/Aluminum

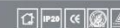

Model: B1010-1

灯具功率/Light Power: COB 20W
输入电压/Input Voltage: AC90-265V 50Hz/60Hz
光通量/Luminous Flux: 1600LM
显色指数/CRI: Ra ≥ 80
色温/Color Temperature: 3000K

内箱尺寸/Box size: 135x135x135mm
外箱尺寸/ Carton size: 710x300x565mm
包装数/Qty/Ctn: 40PCS
灯体材质/Material: 铝/Aluminum



Model: B1010-2

灯具功率/Light Power: COB 2x20W
输入电压/Input Voltage: AC90-265V 50Hz/60Hz
光通量/Luminous Flux: 3200LM
显色指数/CRI: Ra ≥ 80
色温/Color Temperature: 3000K

内箱尺寸/Box size: 232x140x138mm
外箱尺寸/ Carton size: 700x300x480mm
包装数/Qty/Ctn: 20PCS
灯体材质/Material: 铝/Aluminum

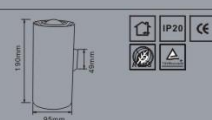

Model: B1006

灯具功率/Light Power: COB 8W
输入电压/Input Voltage: AC180-240V 50Hz/60Hz
光通量/Luminous Flux: 640LM
显色指数/CRI: Ra ≥ 80
色温/Color Temperature: 3000K
内箱尺寸/Box size: 308x139x73mm
外箱尺寸/ Carton size: 560x325x380mm
包装数/Qty/Ctn: 20PCS
灯体材质/Material: 铝/Aluminum





Model: B1008

灯具功率/Light Power: SMD 12W
输入电压/Input Voltage: AC180-240V 50Hz/60Hz
光通量/Luminous Flux: 900LM
显色指数/CRI: Ra≥80
色温/Color Temperature: 3000K

内箱尺寸/Box size: 170x170x66mm
外箱尺寸/ Carton size: 525x345x190mm
包装数/Qty/Ctn: 15PCS
灯体材质/Material: 铝/Aluminum

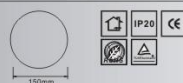

Model: WL01A12S

灯具功率/Light Power: SMD 12W
输入电压/Input Voltage: AC180-240V 50Hz/60Hz
光通量/Luminous Flux: 900LM
显色指数/CRI: Ra≥80

色温/Color Temperature: 3000K/4000K/6000K
外箱尺寸/ Carton size: 590x255x360mm
包装数/Qty/Ctn: 20PCS
灯体材质/Material: 铝/Aluminum



Model: WL01B12C

灯具功率/Light Power: COB 2x6W
输入电压/Input Voltage: AC180-240V 50Hz/60Hz
光通量/Luminous Flux: 900LM
显色指数/CRI: Ra≥80

色温/Color Temperature: 3000K/4000K/6000K
外箱尺寸/ Carton size: 700x300x480mm
包装数/Qty/Ctn: 20PCS
灯体材质/Material: 铝/Aluminum

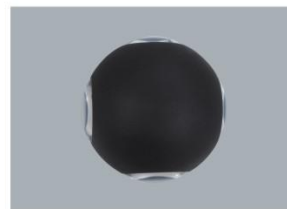
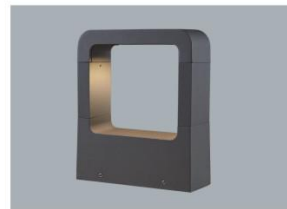

Model: WL01C07C

灯具功率/Light Power: COB 7W
输入电压/Input Voltage: AC180-240V 50Hz/60Hz
光通量/Luminous Flux: 560LM
显色指数/CRI: Ra≥80
色温/Color Temperature: 3000K/4000K/6000K
外箱尺寸/ Carton size: 480x360x370mm
包装数/Qty/Ctn: 60PCS
灯体材质/Material: 铝/Aluminum



Model: WL01D07C

灯具功率/Light Power: COB 7W
输入电压/Input Voltage: AC180-240V 50Hz/60Hz
光通量/Luminous Flux: 560LM
显色指数/CRI: Ra≥80
色温/Color Temperature: 3000K/4000K/6000K
外箱尺寸/ Carton size: 550x370x440mm
包装数/Qty/Ctn: 100PCS
灯体材质/Material: 铝/Aluminum



Model: WL01E06C

灯具功率/Light Power: COB 2x3W
输入电压/Input Voltage: AC180-240V 50Hz/60Hz
光通量/Luminous Flux: 480LM
显色指数/CRI: Ra≥80
色温/Color Temperature: 3000K/4000K/6000K
外箱尺寸/ Carton size: 550x345x440mm
包装数/Qty/Ctn: 60PCS
灯体材质/Material: 铝/Aluminum



Model: B1009

灯具功率/Light Power: COB 7W
输入电压/Input Voltage: AC180-240V 50Hz/60Hz
光通量/Luminous Flux: 560LM
显色指数/CRI: Ra≥80
色温/Color Temperature: 3000K/4000K/6000K
内箱尺寸/Box size: 190x190x77mm
外箱尺寸/ Carton size: 585x400x210mm
包装数/Qty/Ctn: 15PCS
灯体材质/Material: 铝/Aluminum



Model: B1013

灯具功率/Light Power: COB 4x2W
输入电压/Input Voltage: AC180-240V 50Hz/60Hz
光通量/Luminous Flux: 640LM
显色指数/CRI: Ra≥80
色温/Color Temperature: 3000K/4000K/6000K
内箱尺寸/Box size: 117x117x74mm
外箱尺寸/ Carton size: 480x360x390mm
包装数/Qty/Ctn: 60PCS
灯体材质/Material: 铝/Aluminum



RONSE

LED Lawn lamp series



CP7001 P 109



CP7002 P 109



CP7006 P 109



CP7004-1 P 110



CP7005-1(30CM) P 110



Model: CP7001

灯具功率/Light Power: COB 7W
 输入电压/Input Voltage: AC180-240V 50Hz/60Hz
 光通量/Luminous Flux: 560LM
 显色指数/CRI: Ra≥80
 色温/Color Temperature: 3000K

内箱尺寸/Box size: 160x160x275mm
 外箱尺寸/ Carton size: 495x335x295mm
 包装数/Qty/Ctn: 6PCS
 灯体材质/Material: 铝/Aluminum

Model: CP7003-1

灯具功率/Light Power: COB 7W
 输入电压/Input Voltage: AC180-240V 50Hz/60Hz
 光通量/Luminous Flux: 560LM
 显色指数/CRI: Ra≥80
 色温/Color Temperature: 3000K

内箱尺寸/Box size: 160x160x620mm
 外箱尺寸/ Carton size: 635x495x340mm
 包装数/Qty/Ctn: 6PCS
 灯体材质/Material: 铝/Aluminum

Model: CP7002

灯具功率/Light Power: COB 6W
 输入电压/Input Voltage: AC180-240V 50Hz/60Hz
 光通量/Luminous Flux: 420LM
 显色指数/CRI: Ra≥80
 色温/Color Temperature: 3000K

内箱尺寸/Box size: 150x120x730mm
 外箱尺寸/ Carton size: 745x375x320mm
 包装数/Qty/Ctn: 6PCS
 灯体材质/Material: 铝/Aluminum

Model: CP7006

灯具功率/Light Power: COB 7W
 输入电压/Input Voltage: AC180-240V 50Hz/60Hz
 光通量/Luminous Flux: 560LM
 显色指数/CRI: Ra≥80
 色温/Color Temperature: 3000K

内箱尺寸/Box size: 65x65x450mm
 外箱尺寸/ Carton size: 465x340x345cm
 包装数/Qty/Ctn: 25PCS
 灯体材质/Material: 铝/Aluminum

Model: CP7004-1

灯具功率/Light Power: COB 7W
 输入电压/Input Voltage: AC180-240V 50Hz/60Hz
 光通量/Luminous Flux: 560LM
 显色指数/CRI: Ra≥80
 色温/Color Temperature: 3000K

内箱尺寸/Box size: 175x65x310mm
 外箱尺寸/ Carton size: 370x345x330mm
 包装数/Qty/Ctn: 10PCS
 灯体材质/Material: 铝/Aluminum

Model: CP7004-2

灯具功率/Light Power: COB 7W
 输入电压/Input Voltage: AC180-240V 50Hz/60Hz
 光通量/Luminous Flux: 560LM
 显色指数/CRI: Ra≥80
 色温/Color Temperature: 3000K

内箱尺寸/Box size: 175x65x610mm
 外箱尺寸/ Carton size: 625x345x370mm
 包装数/Qty/Ctn: 10PCS
 灯体材质/Material: 铝/Aluminum

Model: CP7005-1(30CM)

灯具功率/Light Power: COB 12W
 输入电压/Input Voltage: AC180-240V 50Hz/60Hz
 光通量/Luminous Flux: 960LM
 显色指数/CRI: Ra≥80
 色温/Color Temperature: 3000K

内箱尺寸/Box size: 165x165x320mm
 外箱尺寸/ Carton size: 510x345x340mm
 包装数/Qty/Ctn: 6PCS
 灯体材质/Material: 铝/Aluminum

Model: CP7005-2(60CM)

灯具功率/Light Power: COB 12W
 输入电压/Input Voltage: AC180-240V 50Hz/60Hz
 光通量/Luminous Flux: 960LM
 显色指数/CRI: Ra≥80
 色温/Color Temperature: 3000K

内箱尺寸/Box size: 165x165x620mm
 外箱尺寸/ Carton size: 635x510x350mm
 包装数/Qty/Ctn: 6PCS
 灯体材质/Material: 铝/Aluminum